



Complete Drive Solutions from a Single Source

Gear units, motors, and variable frequency drives



DRIVESYSTEMS

Our Solution. Your Success.

Complete Drive Solutions from a Single Source



NORD Delivers

NORD offers first-class customer service and support along with full-featured drive solutions that can tackle the toughest requirements. All components are carefully selected and precisely configured to meet your exact specifications. In the rare case that standard components won't meet your needs, our in-house engineering team will work with you to design custom components or a complete customized system.

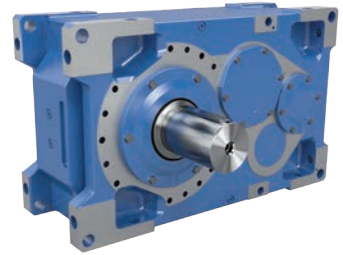

Reduce Lead Times and Decrease Inventory

- ▶ Fastest lead times in the industry with NO expedite fees
- ▶ Over 20,000,000 standard configurations to reduce or eliminate the need for custom components
- ▶ Modular drives, motors, and electronic controls minimize inventory of replacement units and parts



Global Product Designs, Standards, and Support

- ▶ Innovative, industry-standard products to support a wide range of applications
- ▶ Global sales and support network
- ▶ Dedicated mechanical and electrical application engineers ready to assist you
- ▶ Online resources available to you any time
- ▶ 24/7/365 emergency breakdown service



Increase Efficiency and Reduce Operation Costs

- ▶ myNORD online tools for fast selection, configuration, ordering, and tracking of your drive units
- ▶ Drive systems that are perfectly matched to your application for optimum performance and energy efficiency
- ▶ Program personalization, such as weekly shipment schedules and custom nameplates
- ▶ Partner with a company that is easy to do business with and wants to see you succeed!



NORD allows you to customize gear units with a wide range of standard options. Most custom options either do not impact our delivery or do so very minimally.

Standard:

- ▶ Autovent breather
- ▶ QUADRILIP™ sealing
- ▶ High-quality gearing
- ▶ High-strength gear case

Optional:

- ▶ Customer-specific shaft designs
- ▶ Stainless steel output shafts and bores
- ▶ Long-term storage options
- ▶ High/low temperature sealing solutions
- ▶ Back stops
- ▶ Housing modifications
- ▶ Extensive lubrication options, including synthetic, food grade, and low temp
- ▶ Various plug options including oil sight glass and magnetic drain plug
- ▶ Seal options including FKM and NBR



World-Class Service and Support

NORD's customer-first approach means we take extra care to support our customers throughout the entire buying process and beyond. We also offer services such as myNORD online tools and live phone support from 7:00 a.m. to 7:00 p.m. Central Time.

In the rare case of a breakdown, NORD also provides a 24/7/365 emergency hotline for expedited replacement products and parts. At NORD, we do everything possible to keep you moving!



Complete Drive Solutions from a Single Source

Drive Solutions

Drive Electronics

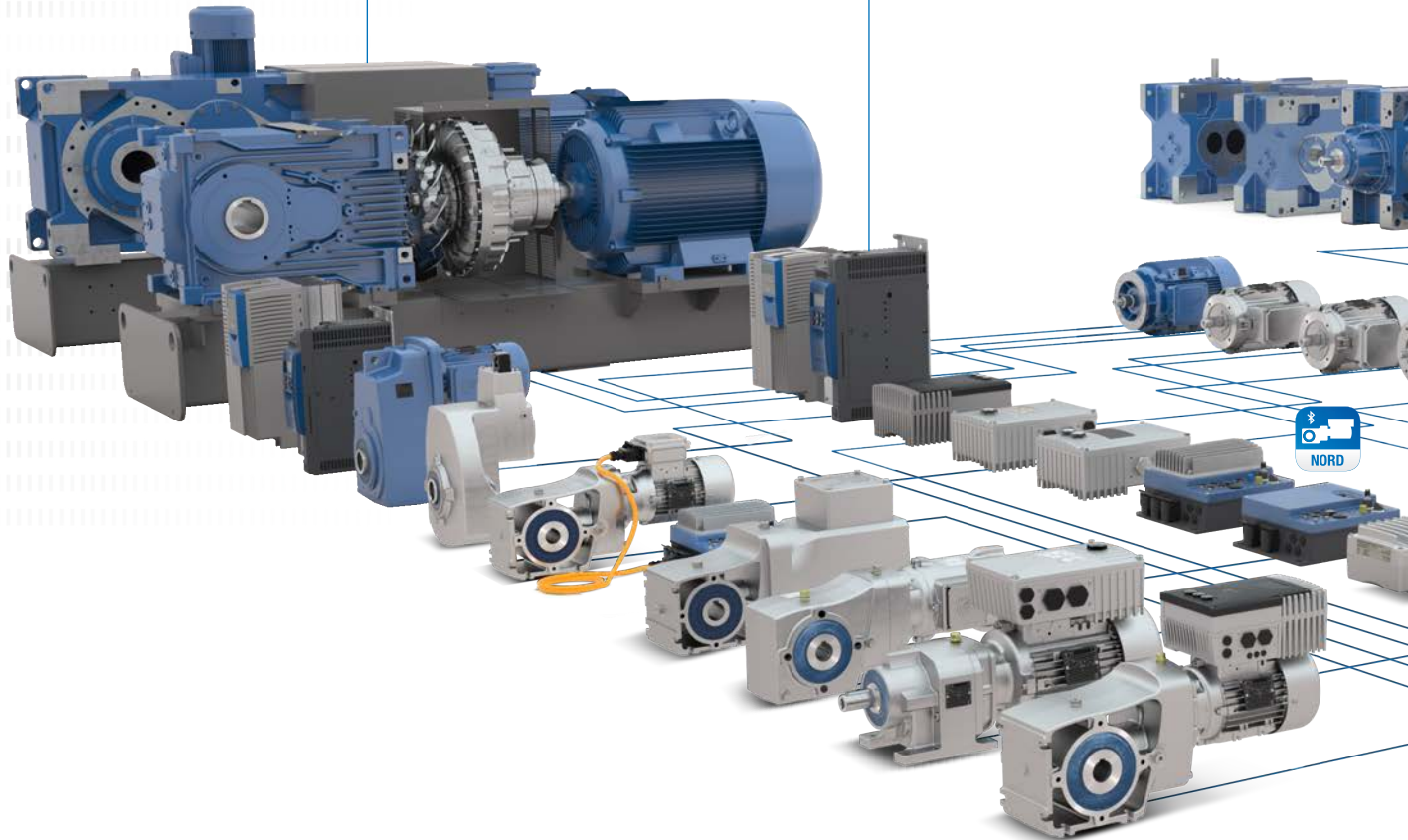

Reliable gear units built with one-piece UNICASE™ housings can cater to any load.

- ▶ High power density
- ▶ Long service life
- ▶ High axial and radial load capacity



Powerful motors up to IE5+ efficiency keep drive systems in motion in all operating situations.

- ▶ Complies with international standards
- ▶ High overload capacity
- ▶ Energy-efficient



Intelligent drive electronics provide the exact control options you need.

- ▶ Scalable functions
- ▶ Full field bus connection facilities
- ▶ Wide power range
- ▶ Integrated PLC at no extra cost

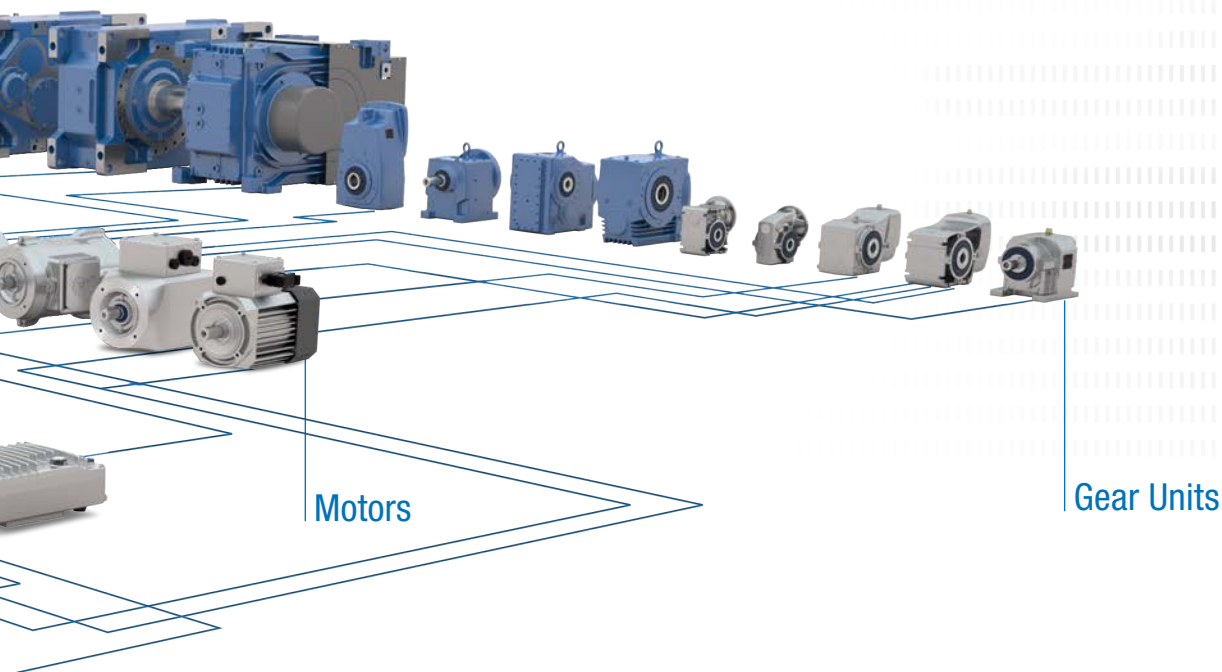

Specialized drive solutions can be created using the modular NORD system consisting of a gear unit, motor, and drive electronics. Each of the variants combine the highest product quality, short planning and assembly times, short lead times, and a good price-to-performance ratio.



Extensive communication options enable access to drives from all levels to enable a wide variety of setting options.

- ▶ Compatible with common industrial Ethernet and fieldbus networks
- ▶ Quick, simple commissioning with a handheld keypad, NORDCON software, or bluetooth adapter and NORDCON mobile app
- ▶ Intralogistics options available



Power disconnects and control switches are located directly on the drives and enable direct starting and stopping as well as fast mode switching.

- ▶ AC line switch
- ▶ Selector switch for local/remote control
- ▶ Start/Stop and Forward/Reverse switch
- ▶ Energy efficient



All interfaces are designed for ease of use for easy configuration and installation.

- ▶ Simple Plug-and-Play with all common connection plugs
- ▶ Plug-in supply cable and motor output
- ▶ Plug-in sensors and encoders
- ▶ Pre-assembled cables
- ▶ Integrated PLC at no extra cost

Complete Drive Solutions from a Single Source

In the early 1980's, NORD DRIVESYSTEMS developed the revolutionary UNICASE™ housing - an enclosed, single-piece housing that is produced from a single piece of material.

- ▶ Housing block integrates all bearing points
- ▶ High output torques
- ▶ High axial and radial load capacity
- ▶ Ultimate reliability
- ▶ Long service life
- ▶ Quiet operation

UNICASE™ Helical Inline Gear Units (Catalog G1000)



- ✓ Foot or flange mounted
- ✓ Long life, low maintenance
- ✓ Closely stepped ratios
- ✓ Cast-iron UNICASE housing

Sizes: 11
Power: 0.16 – 200 hp
Torque: 89 – 230,119 lb-in
Ratio: 2.76:1 – 14,340.31:1

NORDBLOC.1® Helical Inline Gear Units (Catalog G1000)

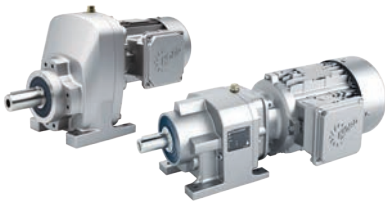

- ✓ Foot or flange-mounted
- ✓ Die-cast iron or aluminum housing
- ✓ UNICASE housing
- ✓ Available in single, double, or triple reduction

Sizes: 16
Power: 0.16 – 50 hp
Torque: 266 – 29,207 lb-in
Ratio: 1.07:1 – 456.77:1

UNICASE™ Parallel Shaft Gear Units (Catalog G1000)

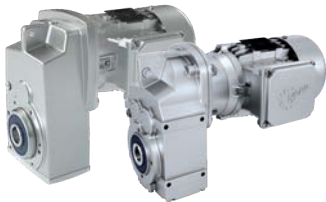

- ✓ Foot, flange, or shaft mounted
- ✓ Hollow or solid shaft
- ✓ Compact design
- ✓ Cast-iron or aluminum UNICASE housing

Sizes: 15
Power: 0.16 – 200 hp
Torque: 974 – 680,200 lb-in
Ratio: 4.03:1 – 15,685.03:1

UNICASE™ Helical Bevel Gear Units (Catalog G1000)



- ✓ Foot, flange, or shaft mounted
- ✓ Hollow or solid shaft
- ✓ Cast-iron UNICASE housing
- ✓ Closely-stepped ratios

Sizes: 11
Power: 0.16 – 200 hp
Torque: 1,593 – 442,537 lb-in
Ratio: 8.04:1 – 13,432.68:1

NORDBLOC.1® 2-Stage Helical Bevel Gear Units (Catalog G1000)

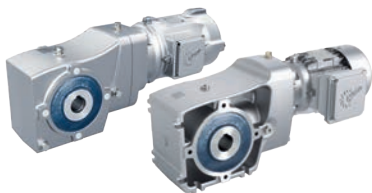

- ✓ Foot, flange, or shaft mounted
- ✓ Hollow or solid shaft
- ✓ Aluminum housing
- ✓ Compact design

Sizes: 6
 Power: 0.16 – 10 hp
 Torque: 443 – 5,842 lb-in
 Ratio: 3.03:1 – 70:1

UNICASE™ Worm Gear Units (Catalog G1000)



- ✓ Foot, flange, or shaft mounted
- ✓ Hollow or solid shaft
- ✓ Cast-iron or aluminum UNICASE housing
- ✓ Closely-stepped ratios

Sizes: 6
 Power: 0.16 – 20 hp
 Torque: 823 – 27,066 lb-in
 Ratio: 4.40:1 – 7,095.12:1

UNIVERSAL SI Worm Gear Units (Catalog G1000)



- ✓ Modular aluminum housing
- ✓ Universal mounting design
- ✓ Life-long lubrication
- ✓ NEMA or IEC input versions

Sizes: 5
 Power: 0.16 – 5.00 hp
 Torque: 186 – 3,780 lb-in
 Ratio: 5.00:1 – 3,000.00:1

UNIVERSAL SMI Worm Gear Units (Catalog G1000)



- ✓ Smooth surface aluminum housing
- ✓ Universal mounting design
- ✓ Life-long lubrication
- ✓ NEMA, IEC, or direct motor mount options

Sizes: 5
 Power: 0.16 – 5.00 hp
 Torque: 186 – 3,780 lb-in
 Ratio: 5.00:1 – 3,000.00:1

DuoDrive Integrated Gear Unit and Motor (Catalog G5010)



- ✓ Integrated gear unit and motor
- ✓ System efficiency up to 92%
- ✓ Simple plug-and-play commissioning
- ✓ High power density

Sizes: 2
 Power: 0.50 – 4.00 hp
 Torque: 230 – 2,186 lb-in
 Ratio: 3.24:1 – 18.1:1

Complete Drive Solutions from a Single Source

Screw Conveyor Package (Catalog G1129)



- ✓ Direct coupled input design
- ✓ Closely stepped ratios
- ✓ Standard CEMA mounting
- ✓ Compact and cost-effective

Sizes: 11
Power: 0.16 – 60 hp
Torque: Up to 53,100 lb-in
Ratio: 4.32:1 – 4,246.38:1

Overhead Conveyors (Catalog G1043)



- ✓ High overhung load capacity
- ✓ QUADRILIP™ sealing system
- ✓ Low maintenance, long service life
- ✓ Industry standard mounting and shafts

Sizes: 3
Power: 0.33 – 60 hp
Torque: Up to 75,225 lb-in
Ratio: 8.10:1 – 3,735.92:1

Flexible Input Options

There are many available input options for our smallest gear boxes to our powerful MAXXDRIVE® units.

- ▶ NEMA
- ▶ IEC
- ▶ Integral gearmotors
- ▶ Solid input shafts
- ▶ Servo adapters
- ▶ Custom inputs

Cut-Pinions

NORD offers precisely machined, single-piece pinions that do not require a separate gear to be pressed into the input shaft. This provides a number of benefits, including:

- ▶ High gear ratios per stage
- ▶ Smaller ratio steps
- ▶ More ratio options in each case size
- ▶ Various inputs available
 - ▶ NEMA adapters
 - ▶ IEC adapters
 - ▶ W-inputs



Shrink Disc

Shrink discs provide a keyless friction connection between a gear reducer's hollow-bore and the driven machine's shaft. NORD hollow bore gear units (type AZ) can be supplied with a shrink disc or a heavy-duty shrink disc (VS) in a wide variety of imperial and metric bore sizes. Heavy duty shrink discs offer increased clamping force and a higher degree of safety against slippage for demanding applications.

NORD shrink discs offer several advantages:

- ▶ High-capacity interference fit delivers positive benefits of traditional friction fits without the typical assembly and disassembly problems
- ▶ Proper assembly tolerances ensure connections can be released even after long periods of operation
- ▶ Elimination of keys and keyways results in a stronger solid shaft and no key crushing or pounding failures
- ▶ Shrink disc connections are backlash-free, extremely concentric, well-balanced, and are ideal for positioning applications, reversing applications, and higher speed applications
- ▶ Eliminates shaft fretting corrosion by nature of the interference fit
- ▶ Provides easy alignment and simple axial and angular timing of mounted or driven shaft components

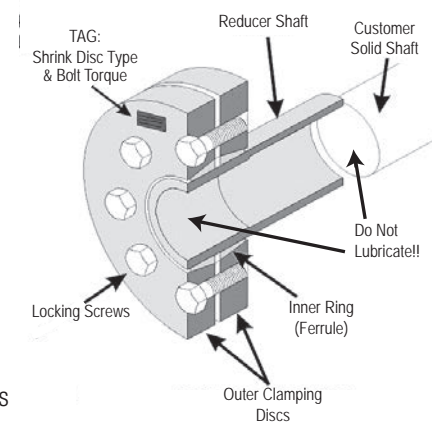

GRIPMAXX™

A keyless bushing system for shaft-mounting drives that can accommodate a wide range of solid shaft sizes while ensuring high-capacity, zero-backlash fit. Eliminates assembly and disassembly challenges by offering generous clearances for easy installation and removal of the gearbox.

- ▶ Extensive bore flexibility*
- ▶ No special shaft tolerances: utilize readily available cold-finished shaft stock*
- ▶ Simplified install and removal
- ▶ Bushings are corrosion resistant
- ▶ Optimally designed for shaft mounted or torque arm mounted units
- ▶ Available with UNICASE™ helical bevels, two-stage bevels, UNICASE parallel shaft, and UNICASE helical worm units

**Shrink disc keyless bore offering available for non-stock bore sizes. Assembly tolerances require more precision than shafts connected with GRIPMAXX bushing kit.*

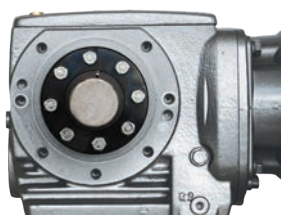

A shrink disc helps in the assembly or disassembly process

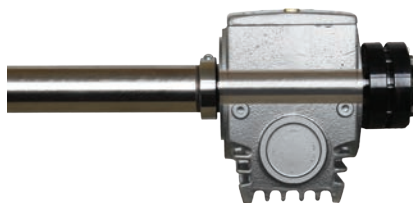

The GRIPMAXX fits tightly against a shouldered shaft



Easy installation and removal

Complete Drive Solutions from a Single Source

NORD DRIVESYSTEMS is the only manufacturer that produces modular industrial gear units with an output torque of up to 2,495,900 lb-in in a one-piece UNICASE™ housing.

- ▶ UNICASE housing, no joints subject to torque
- ▶ All bearing points and sealing surfaces are machined in a single operation
- ▶ High precision axis alignment, quiet operation
- ▶ Long life, low-maintenance
- ▶ Helical and bevel gear units

MAXXDRIVE® Parallel Industrial Gear Units (Catalog G1050)

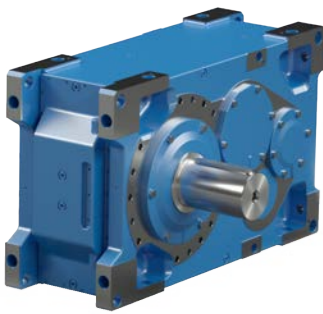

- ▶ Universal gear units
- ▶ 2- and 3-stage
- ▶ Multiple mounting and cooling options
- ▶ Modified bearing options for high radial and axial load capacity
- ▶ Compact design
- ▶ All installation positions

Size: 11
Power: 2.00 – 8,075 hp
Torque: 132,800 – 2,495,900 lb-in
Ratio: 5.54:1 – 30,000:1

MAXXDRIVE® Right-Angle Industrial Gear Units (Catalog G1050)

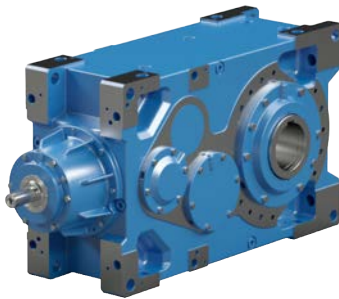

- ▶ Universal gear units
- ▶ 3- and 4-stage
- ▶ Multiple mounting and cooling options
- ▶ Modified bearing options for high radial and axial load capacity
- ▶ Compact design
- ▶ All installation positions

Size: 11
Power: 2.00 – 2,850 hp
Torque: 132,800 – 2,301,200 lb-in
Ratio: 12.61:1 – 30,000:1

MAXXDRIVE® XT Right-Angle Industrial Gear Units (Catalog G1050)

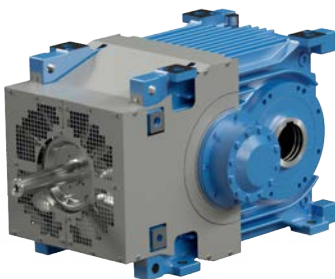

- ▶ 2-stages
- ▶ Thermally optimized housing design
- ▶ Integrated high power axial fan
- ▶ High powers with low speed ratios
- ▶ Optimized for horizontal installation orientation
- ▶ Ideal for applications such as belt or bucket conveyors

Size: 7
Power: 30 – 2,825 hp
Torque: 132,800 – 663,800 lb-in
Ratio: 6.14:1 – 22.91:1

Industrial Gear Unit Modules

Highly configurable components allow NORD to provide a wide variety of system variants as well as great flexibility, short planning, and assembly times without the need for costly custom components. This modular concept also enables drive solutions to be individually tailored to your requirements with short delivery times, even for large gear units.

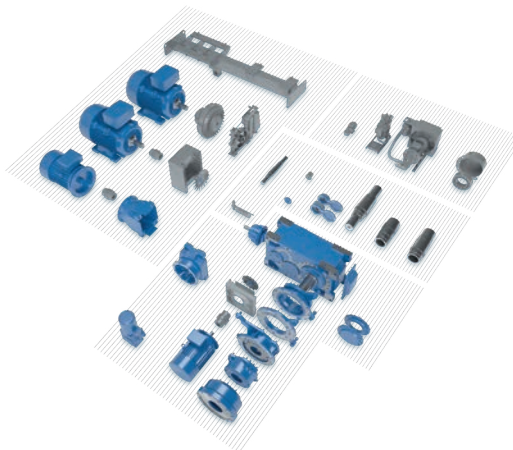

MAXXDRIVE® XD Parallel Industrial Gear Units (Flyer S1056)

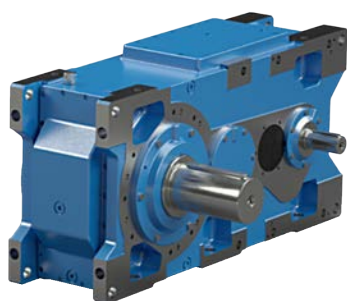

- ▶ 3- and 4-stage reductions feature same footprint dimensions
- ▶ Center distance increased by +35%
- ▶ Inspection cover
- ▶ Optimized housing for downward radial loads
- ▶ Ideal for lifting equipment

Size: 10
 Power: 1.00 – 8,075 hp
 Torque: 60,200 – 2,496,000 lb-in
 Ratio: 5.6:1 – 400:1

MAXXDRIVE® XJ Right-Angle Industrial Gear Units

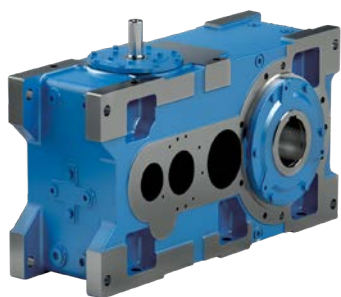

- ▶ 3-stage
- ▶ New input shaft position “J-Mount”
- ▶ Horizontal and vertical installation positions
- ▶ Modular
- ▶ Flexible

Size: 5
 Power: 7.50 – 1,710 hp
 Torque: 132,761 – 947,030 lb-in
 Ratio: 12.5:1 – 100:1

MAXXDRIVE® Complete Drive Systems (Catalog G1050)



- ▶ Complete drive systems consisting of the gear unit, motor, and drive electronics
- ▶ Wide selection of other components, e.g. couplings, brakes, etc.
- ▶ Standardized solutions for rockers and base frames, e.g. for belt conveyors or bucket elevators, etc.
- ▶ Systems tailored to applications, e.g. agitators, hoists, extruders, etc.
- ▶ Individually adaptable

Complete Drive Solutions from a Single Source

NORD DRIVESYSTEMS develops its own motors and supplies them to all major markets throughout the world. These include IE1, IE3, IE4, and IE5+ high-efficiency electric motors.

Our own developments and in-house production ensure a high level of independence from external suppliers and therefore provide our customers with the decisive advantage of short and highly dependable delivery times.

NORD motors meet all common global efficiency regulations and standards. Energy directive overviews can be found at www.nord.com.

International Energy Efficiency Standards

- ▶ EU: IE1 – IE4 as per IEC 60034-30
- ▶ US: ee labeling as per EISA 2007 (Dept. of Energy)
- ▶ CA: CSA energy verified as per EER 2010
- ▶ CN: CEL as per GB 18613
- ▶ KR: KEL as per REELS 2010

Standard Asynchronous Motors (Catalog M7000)

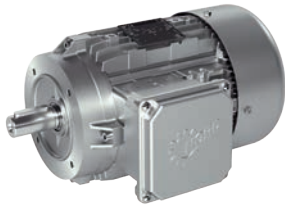

- ✓ Global approval and acceptance
- ✓ Extensive options available
- ✓ VFD/Inverter duty
- ✓ High overload reserves

Sizes: 63 – 250
Power: 0.16 – 75 hp
Number of poles: 2, 4, 6
Efficiency class: IE1, IE3

Switchable Pole Asynchronous Motors (Catalog M7000)

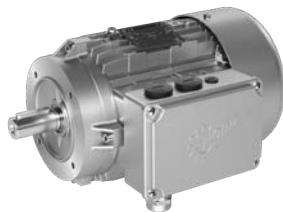

- ✓ ISO F used according to class B
- ✓ Protection class IP55, optional IP66
- ✓ Two fixed speeds

Sizes: 63 – 160
Power: 0.13 – 22 hp
Number of poles: 4-2, 8-2, 8-4, others on request
Efficiency class: IE1

Single-Phase Asynchronous Motors (Catalog M7000)



- ✓ Starting and operating capacitors
- ✓ NEMA/IEC adapter options
- ✓ Global approval and acceptance

Sizes: 63 – 90
Power: 0.16 – 2.00 hp
Number of poles: 4
Efficiency class: IE1

Smooth Surface Motors (Catalog M7000)



- ✓ Wash-down design
- ✓ Various motor protection options
- ✓ IP66 or IP69K protection
- ✓ Inverter/vector duty

Sizes: 71 – 100
Power: 0.16 – 1.50 hp
Number of poles: 4
Efficiency class: IE3

IE5+ Synchronous Motors (Catalog M5000)

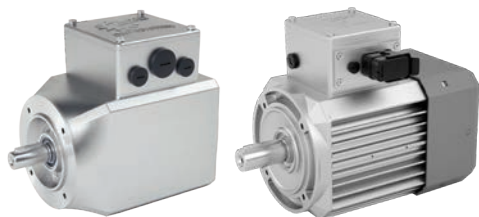

- ✓ Constant torque over wide speed range
- ✓ NEMA, IEC, or direct motor mounting
- ✓ Optional IP69K
- ✓ Variant reduction

Sizes: 71, 90
 Power: Ventilated (TEFC): 0.50 – 5.00 hp
 Non-ventilated (TENV): 0.50 – 3.00 hp
 Number of poles: 8
 Efficiency class: IE5+

IE4 Standard Synchronous Motors (TI60-0001 and TI60-0004)



- ✓ ISO B
- ✓ Only for VFD operation
- ✓ Open or closed loop operation
- ✓ High overload reserves

Sizes: 80 – 100
 Power: 1.50 – 7.50 hp
 Number of poles: 4
 Efficiency class: IE4

Explosion-Protected Motors for Gas Atmospheres (Catalog G2122)



- ✓ Class I, Division 2, Groups A, B, C, D
- ✓ Temperature Code: T3B (165°C)

Sizes: 63 – 180
 Power: 0.16 – 30 hp
 Number of poles: 4
 Efficiency class: IE1 (0.16 – 0.75 hp), IE3 (1.00 – 30 hp)

Explosion-Protected Motors for Dust Atmospheres (Catalog G2122)



- ✓ Class II, Division 2, Groups F, G
- ✓ Temperature Code: T3B (165°C)
- ✓ Inverter duty (IE3 only)

Sizes: 63 – 180
 Power: 0.16 – 30 hp
 Number of poles: 4
 Efficiency class: IE1 (0.16 – 0.75 hp), IE3 (1.00 – 30 hp)

Complete Drive Solutions from a Single Source

NORD DRIVESYSTEMS manufactures variable frequency drives and motor starters for precise control of drive systems. VFD solutions are available for conventional control cabinet installations as well as for decentralized, fully-integrated gear units.

SK 135E NORDAC® *START* Motor Starters (Catalog E3000)



- ✓ Integrated electronic brake rectifier
- ✓ Reversing starter with soft start function
- ✓ Consistent parameter structure

Sizes: 2
Voltage: 3~ 200 – 240 V, 3~ 380 – 500 V
Power: 0.16 – 4 hp resp. up to 10 hp

SK 180E NORDAC® *BASE* Variable Frequency Drives (Catalog E3000)



- ✓ Stand-alone operation
- ✓ Sensorless current vector control (ISD control)
- ✓ 4 parameter sets
- ✓ Integrated PLC

Sizes: 2
Voltage: 1~ 110 – 120 V, 1~ 200 – 240 V, 3~ 200 – 240 V, 3~ 380 – 500 V
Power: 0.33 – 3 hp

SK 200E NORDAC® *FLEX* Variable Frequency Drives (Catalog E3000)



- ✓ Energy saving function
- ✓ Integrated PLC
- ✓ Integrated POSICON positioning control

Sizes: 4
Voltage: 1~ 110 – 120 V, 1~ 200 – 240 V, 3~ 200 – 240 V, 3~ 380 – 500 V
Power: 0.33 – 30 hp

SK 250E NORDAC® *LINK* Field Distributors (Catalog E3000)



- ✓ Variable frequency drive or motor starter
- ✓ All connections in plug-in version for easy commissioning and maintenance
- ✓ PLC functionality for drive-integrated functions

Sizes: 3
Voltage: 3~ 380 – 500 V
Power: VFD 0.75 – 10 hp; Motor starter 0.16 – 4 hp

NORDAC® *ON/ON+* Variable Frequency Drives (Catalog E3000)

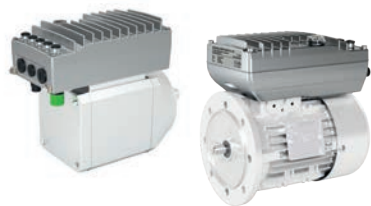

- ✓ Wall or motor mounted
- ✓ Ethernet communication
- ✓ Compact design
- ✓ Plug-and-Play solution

NORDAC *ON*
 Sizes: 3
 Voltage: 3~ 400V
 Power: 0.50 – 3 hp

NORDAC *ON+*
 Sizes: 3
 Voltage: 3~ 400V
 Power: 0.50 – 4 hp

SK 500P NORDAC® *PRO* Variable Frequency Drives (Catalog E3000)



- ✓ Precise current vector control with high overload reserves for operating asynchronous and synchronous motors
- ✓ Universal interface for real time Ethernet
- ✓ Integrated PLC for drive-related functions even in the basic device

Size: 5
 Voltage: 1~ 200 – 240 V, 3~ 380 – 480 V
 Power: 0.33 – 30 hp

SK 500E NORDAC® *PRO* Variable Frequency Drives (Catalog E3000)



- ✓ Stand-alone operation
- ✓ 4 parameter sets
- ✓ Sensorless current vector control (ISD control)
- ✓ Integrated PLC

Size: 11
 Voltage: 1~ 110 – 120 V, 1~ 200 – 240 V, 3~ 200 – 240 V, 3~ 380 – 480 V
 Power: 0.33 – 200 hp

NORDAC® *ACCESS BT* (Flyer S9090)



- ✓ Stand-alone parameter memory
- ✓ Bluetooth interface for VFDs and NORDCON APP
- ✓ Data transfer to PC via USB
- ✓ Can be plugged in or disconnected during operation

NORDCON® *APP* (Flyer S9090)



- ✓ Dashboard-based visualization for drive monitoring and fault diagnosis
- ✓ Individually configurable oscilloscope function for drive analysis
- ✓ Parameterization with Help-function and rapid access to parameters
- ✓ Backup and recovery function for simple handling of drive parameters



The NORDCON APP and NORDAC ACCESS BT – a mobile commissioning and service solution for all NORD drives.

Complete Drive Solutions from a Single Source

PROFIsafe

- ▶ Easy implementation of safe reactions available for NORDAC FLEX and NORDAC LINK
- ▶ Comprehensive safety for reliable operation of plant and machinery
- ▶ Functional safety with a single network cable
- ▶ Minimum wiring effort
- ▶ Global availability of fail-safe machine data

Safe Motion PROFIsafe via PROFINET with module SK TU4-PNS

Safety functions for drives according to IEC 61800-5-2

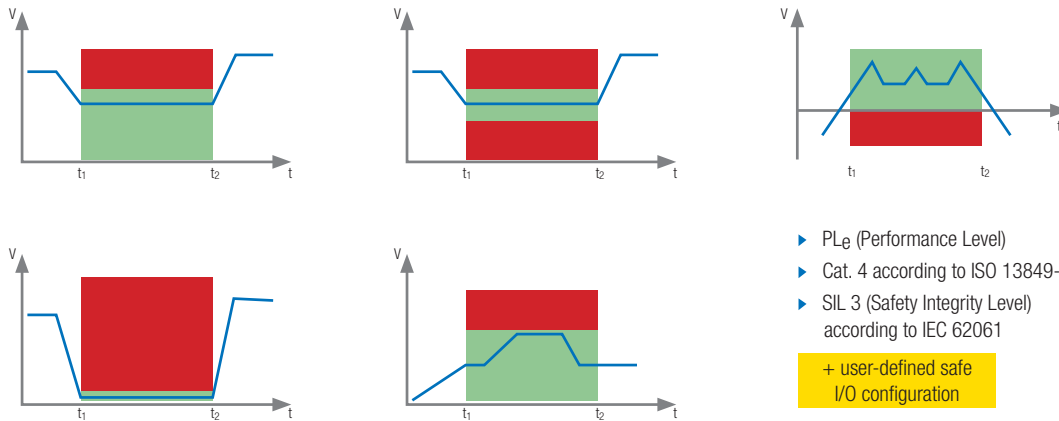

- ▶ PL_E (Performance Level)
- ▶ Cat. 4 according to ISO 13849-1
- ▶ SIL 3 (Safety Integrity Level) according to IEC 62061

+ user-defined safe I/O configuration

No.	Parameter Name	Parameter Set 1	Parameter Set 2	Parameter Set 3	Parameter Set 4	Unit
401.0	Motor Name	10	10	10	10	V
401.1	Motor Type	10	10	10	10	V
401.2	Motor Power	10	10	10	10	W
401.3	Motor Speed	100	100	100	100	rpm
401.4	Motor Torque	100	100	100	100	Nm
401.5	Motor Inertia	0	0	0	0	kgm²
401.6	Motor Efficiency	0.95	0.95	0.95	0.95	%
401.7	Motor Power Factor	0.9	0.9	0.9	0.9	%
401.8	Motor Temperature	100	100	100	100	°C
401.9	Motor Vibration	10	10	10	10	mm/s
401.10	Motor Humidity	10	10	10	10	%
401.11	Motor Pressure	10	10	10	10	bar
401.12	Motor Flow	10	10	10	10	l/min
401.13	Motor Level	10	10	10	10	m
401.14	Motor Weight	10	10	10	10	kg
401.15	Motor Length	10	10	10	10	m
401.16	Motor Width	10	10	10	10	m
401.17	Motor Height	10	10	10	10	m
401.18	Motor Area	10	10	10	10	m²
401.19	Motor Volume	10	10	10	10	m³
401.20	Motor Density	10	10	10	10	kg/m³
401.21	Motor Mass	10	10	10	10	kg
401.22	Motor Moment of Inertia	10	10	10	10	kgm²
401.23	Motor Torque Constant	10	10	10	10	Nm/A
401.24	Motor Back EMF Constant	10	10	10	10	V/rpm
401.25	Motor Armature Resistance	10	10	10	10	Ω
401.26	Motor Field Resistance	10	10	10	10	Ω
401.27	Motor Armature Inductance	10	10	10	10	mH
401.28	Motor Field Inductance	10	10	10	10	mH
401.29	Motor Armature Time Constant	10	10	10	10	ms
401.30	Motor Field Time Constant	10	10	10	10	ms
401.31	Motor Armature Winding Temperature	10	10	10	10	°C
401.32	Motor Field Winding Temperature	10	10	10	10	°C
401.33	Motor Armature Winding Resistance	10	10	10	10	Ω
401.34	Motor Field Winding Resistance	10	10	10	10	Ω
401.35	Motor Armature Winding Inductance	10	10	10	10	mH
401.36	Motor Field Winding Inductance	10	10	10	10	mH
401.37	Motor Armature Winding Time Constant	10	10	10	10	ms
401.38	Motor Field Winding Time Constant	10	10	10	10	ms
401.39	Motor Armature Winding Thermal Time Constant	10	10	10	10	s
401.40	Motor Field Winding Thermal Time Constant	10	10	10	10	s
401.41	Motor Armature Winding Thermal Resistance	10	10	10	10	°C/W
401.42	Motor Field Winding Thermal Resistance	10	10	10	10	°C/W
401.43	Motor Armature Winding Thermal Capacity	10	10	10	10	J/°C
401.44	Motor Field Winding Thermal Capacity	10	10	10	10	J/°C
401.45	Motor Armature Winding Thermal Time Constant	10	10	10	10	s
401.46	Motor Field Winding Thermal Time Constant	10	10	10	10	s
401.47	Motor Armature Winding Thermal Resistance	10	10	10	10	°C/W
401.48	Motor Field Winding Thermal Resistance	10	10	10	10	°C/W
401.49	Motor Armature Winding Thermal Capacity	10	10	10	10	J/°C
401.50	Motor Field Winding Thermal Capacity	10	10	10	10	J/°C

Automatic Device Configuration (ADC)

The NORD Automatic Device Configuration system features Add-On Instruction (AOI) designed to manage messages sent to a NORD electronic device. These messages can be used to read or write individual parameters in the PLC. The configurator can additionally back up current drive parameters or optionally restore a backup file to the drive. This enables easy drive replacement without the need of programming.

Automatic Device Configurator Functionality

- ▶ Create a backup file to be saved in the PLC
- ▶ Automatically detect when a new drive is connected
- ▶ Program the new drive from the stored backup file
- ▶ Individual read/write of parameters (acyclic comms)

NORD offers an ADC AOI for quick, simple implementation into studio 5000 with tag generation and setup. Download manual BU 0970 to learn more.



Intelligent drives from NORD DRIVESYSTEMS play an important role in highly networked systems to advance the so-called fourth industrial revolution, which is based on extensive exchange of information on all levels to increase efficiency and prevent costly downtime.

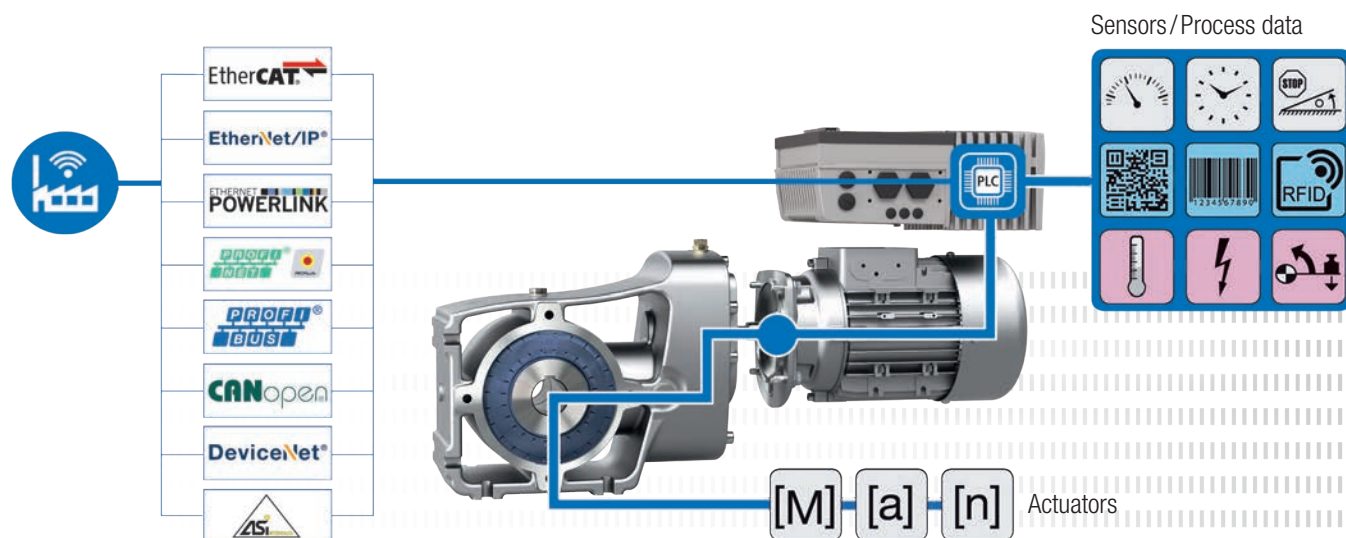

NORD DRIVESYSTEMS – INDUSTRY 4.0 READY!

"NORD 4.0 READY!" means that NORD drives are networked, autonomous, and scalable. The key to this are NORD's variable frequency drives with their powerful processors, comprehensive equipment, interfaces, and functions. They not only monitor the VFD and motor conditions, but also the driven load. The integrated PLC processes data from sensors and actuators, and if necessary, initiates a control sequence to communicate high quality drive and application data to the control center and other networked components.

For example, intelligent sequence controls can enable the drive unit to locally determine what actions are required. The drive units can also coordinate with each other: "Attention, I am sending a package in your direction. Start your conveyor belt." A follower drive can synchronize to a master for a particular task and then return to normal operation. Hundreds of typical functions are saved as unique parameter sets and can be easily adopted.

As a result, the variable frequency drive can coordinate both simple and complex applications independently from the plant control system, and can respond to changes to the process or remedy many process faults without external intervention.

Complete Drive Solutions from a Single Source

Condition Monitoring for Predictive Maintenance

In condition monitoring, operating and status data are regularly or continuously recorded in order to optimize the reliability and efficiency of the plant and machinery. Important information for predictive maintenance can be derived from the data analysis.

The objective is to maintain machines and plants proactively, to reduce downtimes and to increase the efficiency of the entire plant.

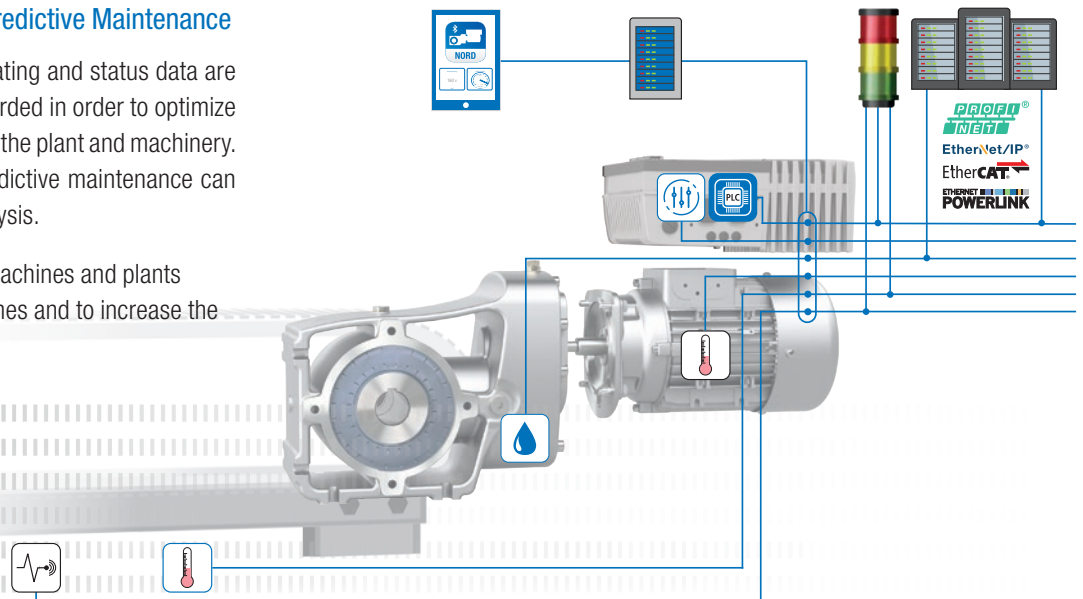

System Vibration Sensor



- ▶ NORD qualified sensors
- ▶ Connection of customized sensors (analog / digital)

System Temperature Sensor



- ▶ PT1000-based motor temperature sensor
- ▶ Ambient or system temperature

Oil Change



- ▶ Determination of the optimal time for oil change on the basis of virtual oil temperature
- ▶ The algorithm is executed in the internal PLC

Drive Parameters



- ▶ Readout of drive system parameters
- ▶ Basis for virtual sensors

Integrated PLC



- ▶ Pre-processing of drive-specific parameters and sensors related to the drive
- ▶ Evaluation of drive conditions

Beacon Signal



- ▶ Local display of drive conditions
- ▶ Scalable display

Local Data Management



- ▶ Processing of drive data for drive and system analysis
- ▶ Condition monitoring

Local Dashboard



- ▶ Display of drive and system data

Higher Level PLC



- ▶ Processing of condition monitoring information by the customer
- ▶ Combination of the collected condition monitoring data with the process data

Drive-Based Approach

Information from condition monitoring can be transferred to predictive maintenance.

- ▶ Sensorless determination of the optimal oil change time based on virtual oil temperature
- ▶ Pre-processing of drive data in the integrated PLC
- ▶ Provision of data to the customer via all common bus interfaces

Temperature Curve of the Oil in the Gear Unit

- ▶ Gear unit parameters and specific operational parameters make it possible to precisely calculate the oil change time
- ▶ The NORD solution is based on the fact that the oil temperature is a key factor for oil aging in gear units
- ▶ No physical temperature sensor, as the virtual sensor continuously calculates the present oil temperature
- ▶ The NORD VFD is used as an evaluation unit: the algorithm is executed in the internal PLC

NORD DRIVESYSTEMS Modular Service Concept

With its modular service concept NORD DRIVESYSTEMS provides solutions for maintaining availability and conserving the value of the drive technology. It provides various services in the form of compact modules, which range from assistance in commissioning to specific maintenance packages, and on-site analysis to estimate repair costs. In addition, there are modernization or optimization measures. Lastly, operators gain the ability to qualify their employees with various training sessions.

NORD Service Modules

- ▶ Installation and commissioning
- ▶ Periodic maintenance and status monitoring
- ▶ Repair, maintenance or replacement
- ▶ Spare parts logistics
- ▶ Product instruction and training
- ▶ Individual contracts
- ▶ 24/7/365 emergency breakdown service
- ▶ Modernization and extension

Complete Drive Solutions from a Single Source

LogiDrive®

The Ideal Solution for Post & Parcel, Airport, and Warehouse

Advanced

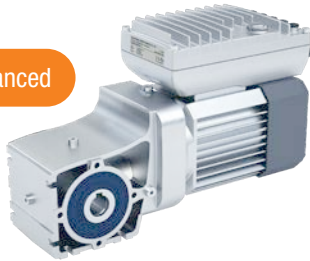

The service-friendly, standardized modular system utilizes NORD products customized to respective industry standards and application requirements. For every area, there are advanced versions with IE5+ permanent magnet synchronous motor technology and a basic version with IE3 asynchronous motors. While the LogiDrive advanced drives address issues such as energy efficiency, version reduction, and Total Cost of Ownership (TCO), the basic LogiDrive's main focus is on cost efficiency.

Advanced



Advanced

- ▶ Focus on energy efficiency, variant reduction, and Total Cost of Ownership (TCO)
- ▶ IE5+ permanent magnet synchronous motors
- ▶ Decentralized variable frequency drive
- ▶ Expandable through optional module
- ▶ Plug-and-Play
- ▶ PLC functionality for drive-related functions

Basic

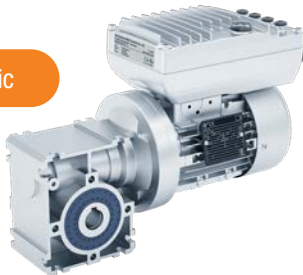

Basic

- ▶ Main focus is cost efficiency
- ▶ IE3 high efficiency motor
- ▶ Decentralized variable frequency drive
- ▶ Flexible gear unit selection - modular
- ▶ Encoder optional
- ▶ PLC functionality for drive-related functions

Basic

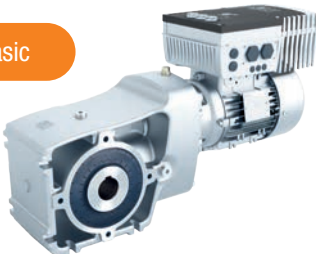

The LogiDrive solution from NORD DRIVESYSTEMS reduces planning and commissioning effort

- ▶ NORD VFDs for intralogistics and airport applications can control both synchronous and asynchronous motors
- ▶ Simple planning with identical housing dimensions for synchronous and asynchronous motors

NORDAC LINK FDS* SK 250 *field distribution system

- ▶ Internal or external braking resistor
- ▶ External 24 V DC supply for the control board, this ensures the same potential for all drive units. The drive units can be accessed via the bus even without the 400 V AC main voltage, as the control board remains active due to the 24V DC supply.
- ▶ Decentralized installation
- ▶ Plug-in VFD
- ▶ Plug-in EEPROM, data can be transferred if servicing is required.



IE5+ Synchronous Motors

The use of IE5+ synchronous motors minimizes overall costs during service life, achieves considerably greater efficiency, and provides a faster return on investment (ROI). IE5+ motors unfold their full potential in applications with partial load ranges and low speed ranges.

Efficiency at Full Load and Partial Speed

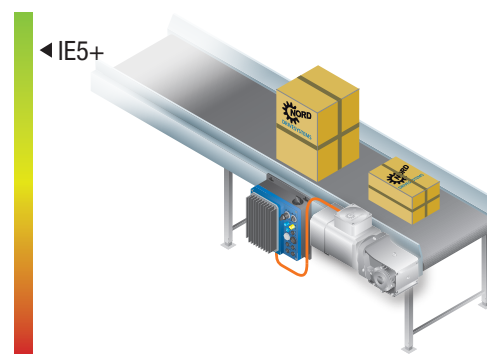
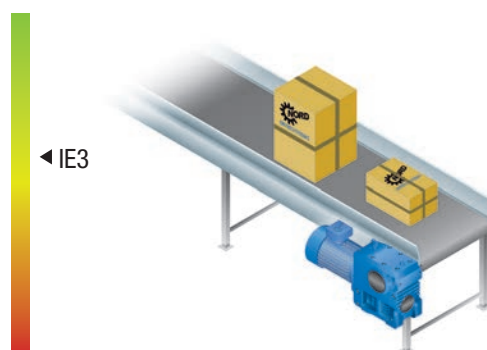

Motor Size	IE3	IE5+
71	0.33 - 0.5 hp	0.5 - 3.0 hp
80	0.75 - 1.0 hp	0.5 - 3.0 hp
90	1.5 - 2.0 hp	1.5 - 4.0 hp
100	3.0 - 4.0 hp	1.5 - 5.0 hp

Complete Drive Solutions from a Single Source

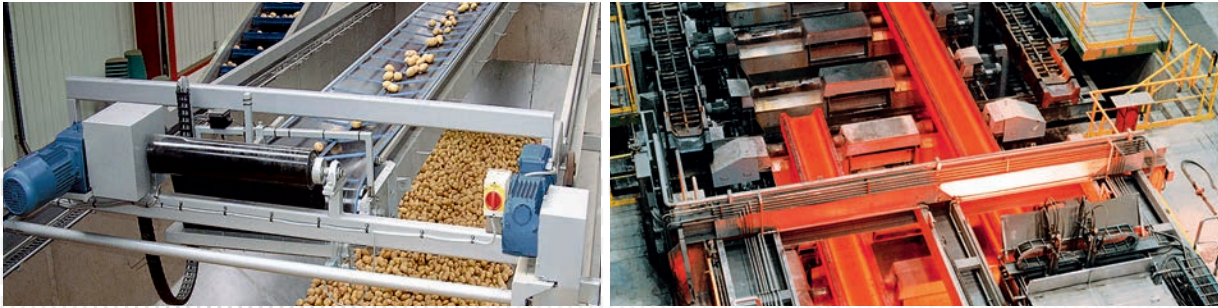

The paint systems used by NORD DRIVESYSTEMS are inherently resistant to chemicals and have been tested for their resistance to all common substances that could have a negative affect on the environment. Once fully dry, NORD paints are food-safe and fulfill the NSF/ANSI 51-2009e test criteria. No further top coats are required.

NORD's protective properties extend beyond paint coatings and surface treatments for its products. All NORD motors and speed reducers are constructed to provide a high degree of protection against wet and severe conditions. A variety of standard and optional features are available to help your NORD gear unit endure the harshest environmental conditions year after year.

Standard Gear Unit Features

- ▶ UNICASE™ housing design
- ▶ AUTOVENT™ breather
- ▶ Factory primer on all cast-iron components
- ▶ Corrosion-resistant nameplate

Optional Gear Unit Features

- ▶ Stainless steel output shafts
- ▶ Stainless steel hardware
- ▶ Custom venting solutions – stainless steel, filtered vents

Standard Motor Features

- ▶ Shaft lip seals on both ends of the motor shaft
- ▶ Sealed stator to endbell connections to exclude moisture
- ▶ Moisture-resistant varnish dipped windings
- ▶ Double coated magnetic wire insulation
- ▶ Conduit box sealed with gaskets
- ▶ Corrosion-resistant alloy materials
- ▶ Tropical protection – inorganic insulating components

Optional Motor Features

- ▶ IP66 enclosure protection (IP55 standard)
- ▶ Condensation drain holes (KB or KBO)
- ▶ Resin-sealed terminal box (KKV)
- ▶ Epoxy-dipped motor windings (EP)
- ▶ Drip covers – canopy cover or double fan cover (RD or RDD)
- ▶ Totally Enclosed Non-Ventilated (TENV)
- ▶ Space Heaters (SH)
- ▶ Brake protection options
 - ▶ Stainless steel brake plate (RG)
 - ▶ Rubber dust boot with stainless brake plate (SR)
 - ▶ IP66 Sealed Brake
 - ▶ Potted rectifiers

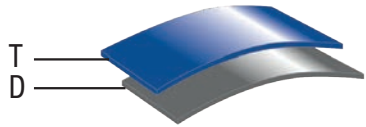
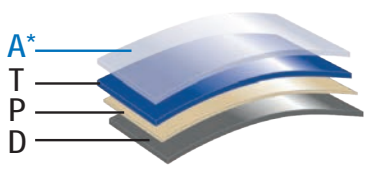
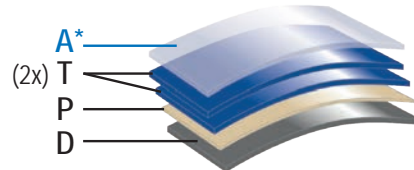
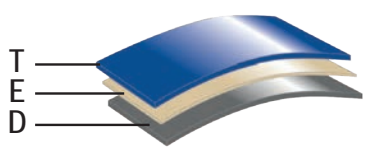
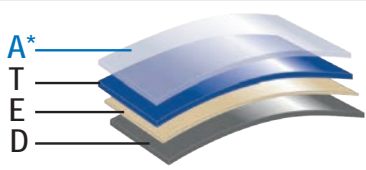
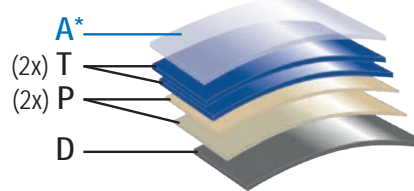
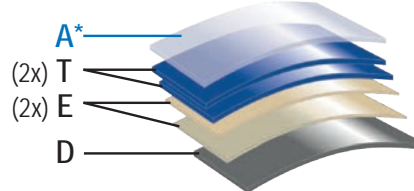
Coating / Field of Application	Class *	Structure
Basic Indoor installation: Unheated buildings where condensation may occur (warehouses, etc...)	C2	 <p>T D</p>
NORD Severe Duty 2 (NSD2) NORD Severe Duty 2+ (NSD2+) Indoor installation: Unheated buildings where condensation may occur (warehouses, etc...) Outdoor installation: Atmosphere with low pollution level, mostly rural areas	C2	 <p>A* T P D</p>
NORD Severe Duty 3 (NSD3) NORD Severe Duty 3+ (NSD3+) Indoor installation: Production rooms with high humidity and increased levels of air pollution, e.g. laundries, breweries, dairies Outdoor installation: Urban and industrial atmosphere with moderate sulfur dioxide pollution and/or coastal atmosphere with low salinity	C3	 <p>A* (2x) T P D</p>
NORD Severe Chem Duty 3 (NSDC3) Indoor installation: Production rooms with high humidity and increased levels of chemical air pollution	C3	 <p>T E D</p>
NORD Severe Food Duty 3 (NSDF3) NORD Severe Food Duty 3+ (NSDF3+) Indoor installation: Production rooms with high humidity and increased levels of air pollution, e.g. food packaging	C3	 <p>A* T E D</p>
NORD Severe Duty 4 (NSD4) NORD Severe Duty 4+ (NSD4+) Indoor installation: Chemical plants, swimming pools, offshore shipyards, and boat harbors Outdoor installation: Industrial or coastal atmosphere with moderate salinity	C4	 <p>A* (2x) T (2x) P D</p>
NORD Severe Duty 5 (NSD5) NORD Severe Duty 5+ (NSD5+) Indoor installation: Buildings or areas with near-permanent condensation and high levels of pollution Outdoor installation: Industrial areas with high humidity, aggressive environments, or coastal atmosphere with high salinity	C5	 <p>A* (2x) T (2x) E D</p>

A*	Optional clear top coat (+ versions)		
T	2-Component Polyurethane Top Coat	P	2-Component Polyurethane Primer
E	2-Component EP Zinc Phosphate Primer	D	Single Component Dip Primer (for cast-iron units only)

* Comparable to DIN EN ISO 12944-2 classification of ambient conditions
 Protocol of the coating thickness based on ISO 19840 available on request

Ordering is Easy With myNORD Online Tools!

- ▶ Obtain drawing files direct from quote configuration
- ▶ Effortlessly select & configure customized drive solutions
- ▶ Create quotes with account-specific net pricing
- ▶ Order-specific documentation
- ▶ 24/7/365 order tracking
- ▶ Select and order spare parts



Register now at myNORD.com!

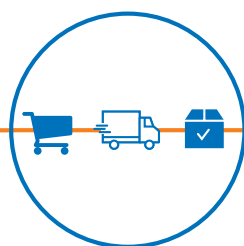

US

Central Region
Corporate Headquarters
800 NORD Drive
Waunakee, WI 53597
Tel. 888.314.6673
info.us@nord.com
www.nord.com

East Region
300E Forsyth Hall Dr.
Charlotte, NC 28273
Tel. 888.314.6673
info.us@nord.com

West Region
1180 Railroad St.
Corona, CA 92882
Tel. 888.314.6673
info.us@nord.com

South Region
350 Cypress Hill Dr, Suite 400
McKinney, TX 75071
Tel. 888.314.6673
info.us@nord.com

CA

NORD Gear Limited
Brampton, ON
41 West Drive
Brampton, ON L6T4A1
Tel. 800.668.4378
info.ca@nord.com

MX

NORD DRIVE SYSTEMS SA DE CV
Queretaro, Mexico
Av. Industria Textil B.6
Parque Industrial PYME, Huimilpan
QRO - Mexico 76950
Tel. 52 442 688 7110
info.mx@nord.com