

# Frequency inverter for decentralised applications

NORDAC *BASE* SK 180E series

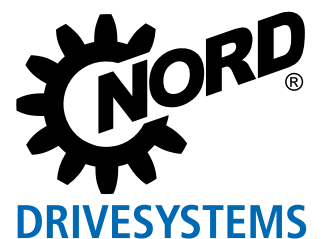

# For standard requirements NORDAC *BASE*, SK 180E series



## NORDAC *BASE*

### NORDAC *BASE*

The advantages of using a frequency inverter to control an electric motor are obvious. Modern frequency inverters offer the typical basic functions such as speed control and communication with control units as well as versions which, for example, can automatically provide positioning and safety functions.

However, many applications do not fully utilise the immense scope of functions of modern frequency inverters. To fill the gap which has resulted between simple motor starters and full featured frequency inverters, NORD has developed a compact model. It concentrates on the essential functions for pumps and conveyor technology (PI / speed control, energy saving, communication with peripherals) and results in significant savings, in both purchase and performance

- ▶ All common drive functions
- ▶ Leakage current <16 mA
- ▶ Consistent parameter structure
- ▶ Stand-alone operation (integrated 24 V power supply)
- ▶ 3 digital inputs and 2 digital outputs
- ▶ 2 analogue inputs (can optionally be used for current or voltage setpoints, or can also be configured as digital inputs e.g. for sensors)
- ▶ 4 parameter sets which can be switched online
- ▶ Process controller / PI controller
- ▶ Energy saving function: "Automatic flux optimisation"

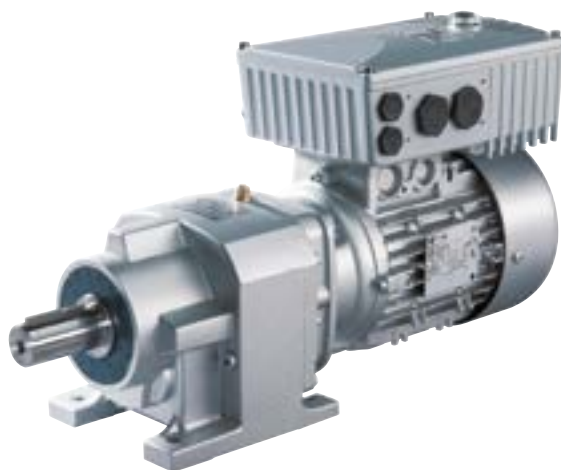

### Optional

- ▶ AS-Interface on board
- ▶ Common bus modules
- ▶ I/O modules
- ▶ System plug connectors (e.g. Harting HAN 10E)
- ▶ Variant for ATEX Zone 22 - 3D
- ▶ Various control options (switches, potentiometer or ParameterBoxes)

### Energy-saving functions

- ▶ Automatic flux optimisation for pump/fan applications
- ▶ Large energy savings
- ▶ Simple setting via parameters

### EMC line filter

#### Category C1 (Class B)

- ▶ All 230 V / 400 V devices have an integrated line filter.
- ▶ Also ideal for applications in a domestic environment, due to compliance with Category C1 (for motor-mounting), or Category C2 (for wall mounting with motor cable up to 5 m long)
- ▶ Suitable for personal protection due to low leakage current (< 16 mA) for operation with universal fault current FI circuit breakers

### Process controller, PI controller

- ▶ All NORDAC *BASE* devices feature integrated analogue inputs.
- ▶ P and I components can be set separately
- ▶ High precision regulation.

# Versatile and sustainable For modern automation systems

Modern automation systems have a wide range of requirements, so that a suitable bus system and drive components must be selected in order to ensure efficient implementation.

For the lower field level, the **AS-Interface** is a cost-effective solution which enables the networking of binary sensors and actuators. With **NORDAC BASE**, a version which provides an appropriate solution by means of an on-board AS-Interface, is available for this price-sensitive area.

The supply voltage (power) is connected separately via the corresponding terminals. An integrated mains unit generates the control voltage for the frequency inverter. This eliminates the need for an additional AUX cable (black).



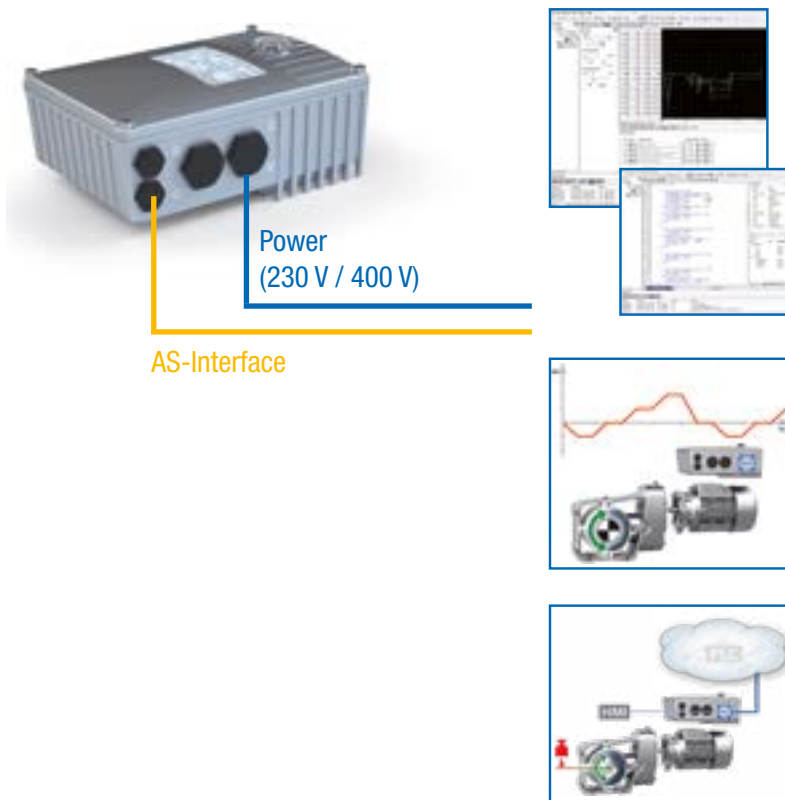



Available in SK 190E



Device SK ...	190E
Slave profile	S-7.A.
Slave type	A/B-Slave
Control voltage	Internal power supply
Inputs/Outputs	4/4
Configuration via parameters	●

# Standards and approvals

All devices of the entire series comply with the standards and directives listed below..

Approval	Directive	Applied standards	Certificates	Code
CE (European Union)	Low Voltage Directive 2014/35/EU	EN 61800-5-1	C310400	
	EMC 2014/30/EU	EN 60529	C310401	
	RoHS 2011/65/EU	EN 61800-3 EN 63000		
	Delegated directive (EU) 2015/863	EN 61800-9-1 EN 61800-9-2		
	Ecodesign 2009/125/EG			
	Regulation (EU) 2019/1781 Ecodesign			
UL (USA)		UL 61800-5-1	E171342	
CSA (Canada)		C22.2 No. 274-13	E171342	
RCM (Australia)	F2018L00028	EN 61800-3	133520966	
EAC (Eurasia)	TR CU 004/2011, TR CU 020/2011	IEC 61800-5-1 IEC 61800-3	EAЭC N RU Д-DE. HB27.B.02730/20	
UkrSEPRO (Ukraine)		EN 61800-5-1 EN 60529 EN 61800-3 EN 63000 EN 60947-1 EN 60947-4 EN 61558-1 EN 50581	C311900	
UKCA (United Kingdom)		EN 61800-5-1 EN 60529 EN 61800-3 EN 63000 EN 61800-9-1 EN 61800-9-2	C350400, C350401	

Devices which are configured and approved for use in explosion hazard environments comply with the following directives and standards.

Approval	Directive	Applied standards	Certificates	Code
CE (European Union)	ATEX	2014/34/EU	EN 60079-0	C432410
	Low Voltage Directive	2014/35/EU	EN 60079-31	
	EMV	2014/30/EU	EN 61800-5-1 EN 60529	
	RoHS	2011/65/EU	EN 61800-3	
	Delegated directive (EU)	2015/863	EN 63000 EN 61800-9-1 EN 61800-9-2	
	Ecodesign	2009/125/EG		
	Regulation (EU)	2019/1781		
	Ecodesign			

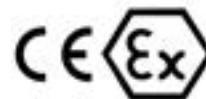

# Type code

## Frequency inverter

SK 180E-370-323-B (-C) (xxx)

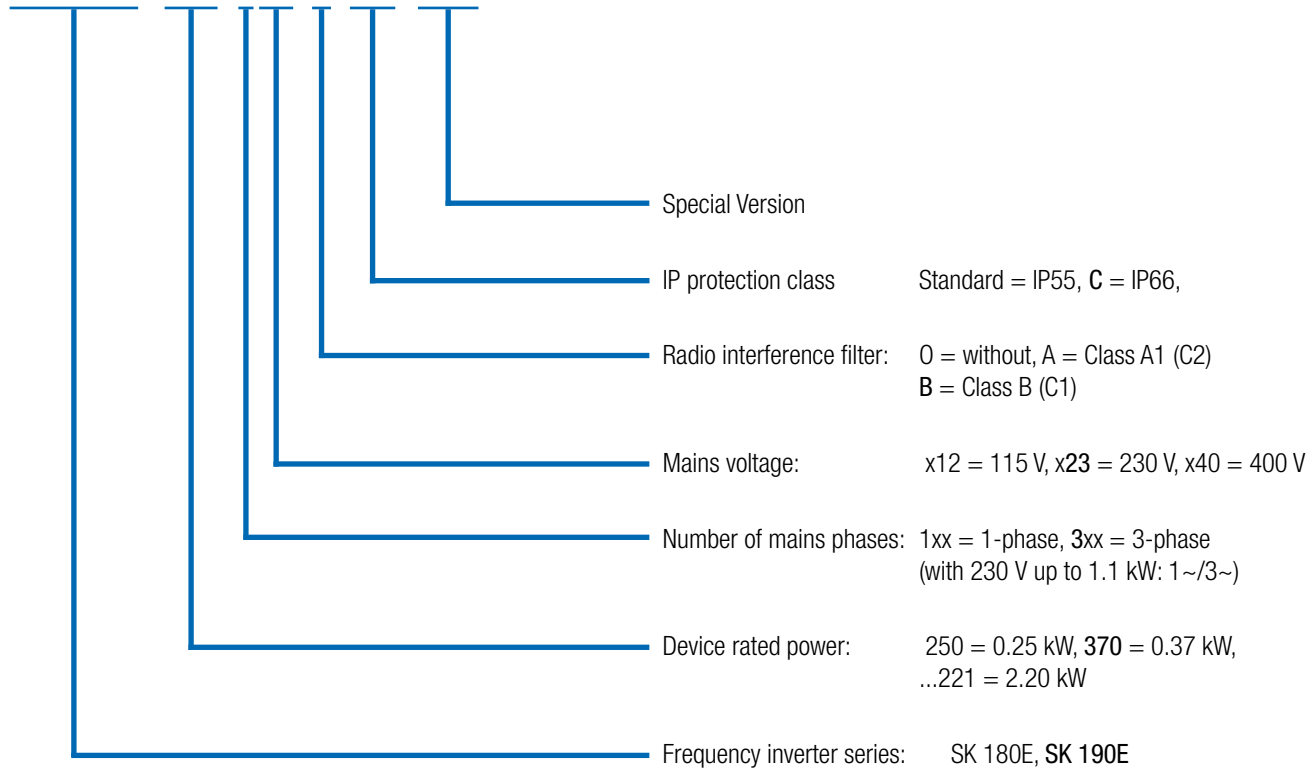

(...) Options, only implemented if required.

## ATEX-compliant drive systems, zone 22 3D

The NORDAC *BASE* can be modified for operation in explosive environments.

This allows the operation of the frequency inverter directly in a hazardous area (ATEX 22-3D). The advantages are obvious:

- ▶ Compact drive unit
- ▶ No complex protective devices
- ▶ No motor cables
- ▶ Optimum EMC
- ▶ Permissible characteristic curves 50 Hz / 87 Hz
- ▶ Control range up to 100 Hz or 3000 rpm

Depending on the area of application (conductive or non-conductive dust) the modification also includes the replacement of the transparent diagnostic caps with a version made of aluminium and glass.

It must be noted that operation of the device within the hazardous area is only permitted with integrable modules (SK CU4 modules, internal braking resistors) or specially approved accessories (ATEX potentiometer „SK ATX-POT“).

There are exceptions for SK TU4 modules, which are described in detail in the manual for the device. Other accessories (e.g. external brake resistors, plug connectors) are not approved for use within a hazardous area.



### Approval

- ▶ According to 2014/34/EU
- ▶ ATEX Zone 22 - 3D
  - ▶ Version for non-conducting dust: IP55
  - ▶ Version for conducting dust: IP66

### Available in all devices



# The entire team

## All device versions at a glance

	SK 180E Size 1+2 0.25 - 2.2 kW	SK 190E Size 1+2 0.25 - 2.2 kW
Motor and wall mounting possible <sup>1</sup>	●	●
Energy bus - loop-through of mains supply cables <sup>2</sup>	●	●
Communication bus for various devices <sup>2</sup>	●	●
Sensorless current vector control (ISD control)	●	●
Brake chopper (braking resistor optional) (Size 2 and above)	●	●
RS-232, RS-485 diagnostic interface	●	●
4 switchable parameter sets	●	●
Parameters pre-set with standard values	●	●
Automatic determination of motor data	●	●
Energy-saving function, optimised efficiency in partial load operation	●	●
Integrated EMC line filter according to EN 61800-3, Category C2 up to 5 m motor cable Category C1 for motor assembly	●	●
Extensive monitoring functions	●	●
Load monitor	●	●
PI controller	●	●
Process controller / compensator control	●	●
PLC functionality	●	●
IE4 Synchronous motor operation (PMSM)	●	●
Modification for operation in an IT network by means of jumpers	●	●
All common field bus systems	●	●
Brake management for mechanical holding brake	●	●
Lifting gear functionality	●	●
AS-Interface on board	○	●
Internal 24 V power supply unit to supply the control board	●	●
Internal / external brake resistors (Size 2)	●	●
Switch and potentiometer versions	●	●
Plug connectors for connection of control, motor and mains cables	●	●

<sup>1</sup> Wall mounting: wall mounting kit required

Motor mounting: an adapter for connection to the motor terminal box may be necessary

<sup>2</sup> Direct connection to the terminal bar or via system plug connectors

● Available as standard

● Optional

○ Not available



# The senses

## Control connections on the frequency inverter

	SK 180E	SK 190E
	Size 1 + 2 0.25 - 2.2 kW	
Control terminals	Number of digital inputs (DIN)	3
	Number of digital outputs (DOUT)	2
	Number of analogue inputs (AIN) <sup>1</sup>	2
	Temperature sensor (PTC)	●
Communication	RS485 / RS232	●
	RJ12	●
	AS-I terminal connection	○

<sup>1</sup> 0(2) - 10 V, 0(4) - 20 mA

Connection and control terminals



Communication

### Note

Control terminals can be supplemented by optional modules (IOs, brake management).

### Status and diagnostic cockpit

The RJ12 interface for connection of a diagnostic and parameterisation tool (e.g. PC with NORD CON software, ParameterBox) is located behind the transparent cover cap. Analysis, diagnostics, parameterisation and monitoring of the drive unit via software is possible during commissioning or service.

In addition to status and readiness indicators, the current overload level, warnings and error messages are indicated in coded form by the LEDs.



# NORDAC *BASE* frequency inverter

## 1 ~ 110 ... 120 V , 1 / 3 ~ 200 ... 240 V UND 3 ~ 380 ... 400 V

<b>Output frequency</b>	0.0 ... 400.0 Hz	<b>Protection class</b>	IP55, optional IP66, NEMA type1
<b>Pulse frequency</b>	3.0 ... 16.0 kHz	<b>Regulation and control</b>	Sensorless current vector control (ISD), linear V/f characteristic curve
<b>Typical overload capacity</b>	150 % for 60 s, 200 % for 3.5 s	<b>Motor temperature monitoring</b>	I <sup>2</sup> t Motor PTC / bi-metal switch
<b>Energy efficiency class</b>	IE2	<b>Leakage current</b>	< 16 mA
<b>Efficiency</b>	> 95 %		
<b>Ambient temperature</b>	-25 °C ... +40 °C (S1) -25 °C ... +50 °C (S3, - 70 % ED)		

Frequency inverters SK 180E...	Nominal motor power		Nominal output current rms [A]	Mains voltage	Output voltage
	230 V [kW]	240 V [hp]			
-250-112-0 (-C)	0.25	1/3	1.7	1 ~ 110...120 V -/+10 % 47 ... 63 Hz	3 ~ AC 0 V up to double the mains voltage
-370-112-0 (-C)	0.37	1/2	2.1		
-550-112-0 (-C)	0.55	3/4	3.0		
-750-112-0 (-C)	0.75	1	3.7		

Frequency inverters SK 180E...	Nominal motor power		Nominal output current rms [A]	Mains voltage	Output voltage
	230 V [kW]	240 V [hp]			
-250-323-B (-C)	0.25	1/3	1.7	1/3 ~ 200 ... 240 V, -/+ 10 % 47 ... 63 Hz	3 ~ AC 0 V up to mains voltage
-370-323-B (-C)	0.37	1/2	2.2		
-550-323-B (-C)	0.55	3/4	3.0		
-750-323-B (-C)	0.75	1	4.0		
-111-323-B (-C)	1.1	1 1/2	5.5		
-151-323-B (-C)	1.5	2	7.0	3 ~ 200 ... 240 V, -/+ 10 % 47 ... 63 Hz	3 ~ AC 0 V up to mains voltage

Frequency inverters SK 180E...	Nominal motor power		Nominal output current rms [A]	Mains voltage	Output voltage
	400 V [kW]	480 V [hp]			
-250-340-B (-C)	0.25	1/3	1.2	3 ~ 380...480 V, -20 % / +10 %, 47 ... 63 Hz	3 ~ AC 0 V up to mains voltage
-370-340-B (-C)	0.37	1/2	1.5		
-550-340-B (-C)	0.55	3/4	1.7		
-750-340-B (-C)	0.75	1	2.3		
-111-340-B (-C)	1.1	1 1/2	3.1		
-151-340-B (-C)	1.5	2	4.0		
-221-340-B (-C)	2.2	3	5.5		

IP66 measures

- ▶ Coated aluminium components
- ▶ Coated circuit boards
- ▶ Low-pressure test
- ▶ Diaphragm valve

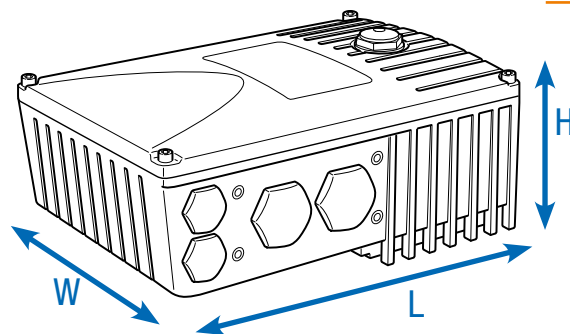

Frequency inverters SK180E ...	Weight [kg]	(Overall) dimensions L x W x H [mm]	Size
-250-112-0 (-C)	2.9	221 x 154 x ca.101	1
-370-112-0 (-C)	2.9	221 x 154 x ca.101	1
-550-112-0 (-C)	2.9	221 x 154 x ca.101	1
-750-112-0 (-C)	2.9	221 x 154 x ca.101	1

Frequency inverters SK180E ...	Weight [kg]	(Overall) dimensions L x W x H [mm]	Size
-250-323-B (-C)	2.9	221 x 154 x ca.101	1
-370-323-B (-C)	2.9	221 x 154 x ca.101	1
-550-323-B (-C)	2.9	221 x 154 x ca.101	1
-750-323-B (-C)	4.1	254 x 165 x ca.123	2
-111-323-B (-C)	4.1	254 x 165 x ca.123	2
-151-323-B (-C)	4.1	254 x 165 x ca.123	2

Frequency inverters SK180E ...	Weight [kg]	(Overall) dimensions L x W x H [mm]	Size
-250-340-B (-C)	2.9	221 x 154 x ca.101	1
-370-340-B (-C)	2.9	221 x 154 x ca.101	1
-550-340-B (-C)	2.9	221 x 154 x ca.101	1
-750-340-B (-C)	2.9	221 x 154 x ca.101	1
-111-340-B (-C)	2.9	221 x 154 x ca.101	1
-151-340-B (-C)	4.1	254 x 165 x ca.123	2
-221-340-B (-C)	4.1	254 x 165 x ca.123	2

# Varied installation possibilities

## Motor Assembly

The frequency inverter can be mounted directly on the terminal box of the (geared) motor, thus forming a perfect unit consisting of the drive and the control technology. This motor-mounted format makes full use of its unbeatable advantages: compact overall dimensions of the drive unit, practically immediate readiness for use after connection to the mains supply thanks to the pre-configuration of the drive unit at the factory, optimum EMC due to short cable lengths - or elimination of a motor cable.

## Wall mounting

As an alternative to motor mounting, the device can be mounted close to the motor with the aid of an optional wall mounting kit.

You can select from different versions depending on the prevalent ambient conditions.

### 1. Standard version SK TIE4-WMK-1-K

Note: If the frequency inverter is wall mounted, the cooling air flow from the motor is not present. This can ultimately result in power restrictions (derating) for the frequency inverter.

### 2. ATEX version SK TIE4-WMK-1-EX

This version is functionally comparable to the standard version, however it is suitable for use in explosion hazard environments (ATEX Zone 22 3D).

Designation	Material No.	Frequency inverters <sup>1</sup> for size FI
SK TIE4-WMK-1-K	275 274 004	BG 1, 2
SK TIE4-WMK-1-EX	275 175 053	BG 1, 2
SK TIE4-WMK-TU <sup>2</sup>	275 274 002	Typ: SK TU4-

<sup>1</sup> Mounting of the WMK underneath the motor starter

<sup>2</sup> Mounting of the WMK on the connection unit of the technology unit

## Motor-mounted or wall-mounted frequency inverters

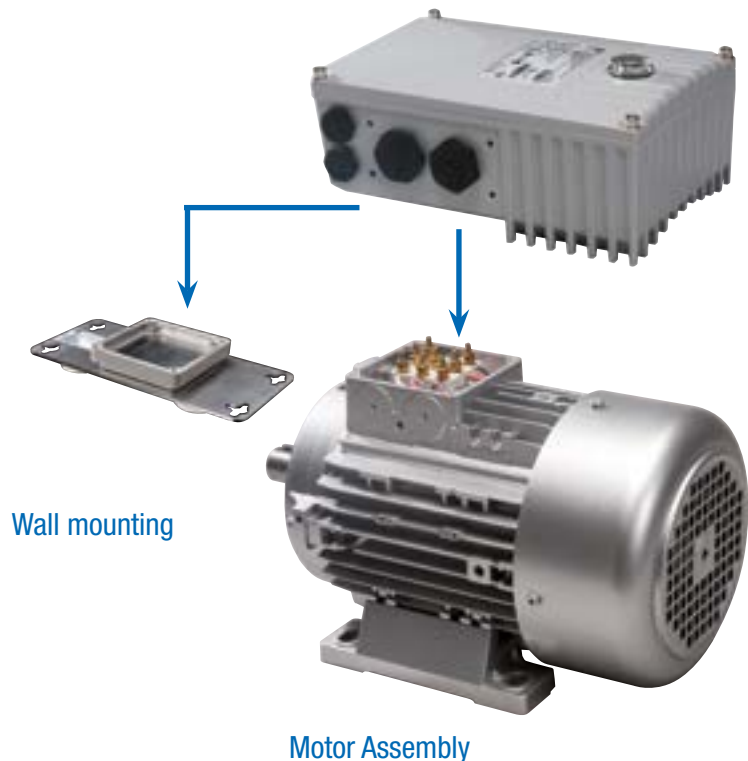

Designation	Material	Integrated fan	Achievable protection class	Weight [kg]	(Overall) dimensions L x W x H [mm]	Remarks
SK TIE4-WMK-1-K	Plastic	○	IP66	0.2	205 x 95 x 5	Note: derating as necessary
SK TIE4-WMK-1-EX	Stainless steel	○	IP66	0.6	205 x 95 x 4	Note: derating as necessary
SK TIE4-WMK-TU	Stainless steel	○	IP66	0.4	155 x 85 x 3	

<sup>1</sup> H = Increase in the total height of the device if mounted on the wall mounting kit

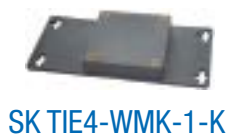
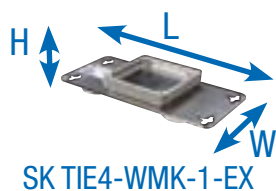

Technology unit on NORDAC BASE or wall mounting



# Brake resistors (only for Size 2 devices)

## internal versions

### Internal braking resistors SK BRI4

Internal brake resistors are intended for applications in which slight or only sporadic and brief braking (e.g. continuous conveyor equipment, mixing equipment) is to be expected. In addition, they enable the use of the frequency inverter in very confined spaces or in an explosive atmosphere.

Internal brake resistors are intended for installation in the connection unit of the frequency inverter. The units offer space for implementing one brake resistor each. For thermal reasons, the rated continuous output is limited to 25%.

Equipment with a brake resistor has to be specified additionally during ordering. Retrofitting is not possible.



Frequency inverters SK 180E / SK190E		Resistor type	Material No.	Resistance [Ω]	Continuous output <sup>1</sup> [W]	Power consumption <sup>2</sup> [kW]
1/3~ 230 V	0.75 ... 1.5 kW	SK BRI4-1-200-100	275 272 008	200	100 / 25 %	1.0
3~ 400 V	1.5 ... 2.2 kW	SK BRI4-1-400-100	275 272 012	400	100 / 25 %	1.0

<sup>1</sup> Reduction of the continuous output of the braking resistor to 25% of the rated output

<sup>2</sup> Permissible max. once within 10 s

# Brake resistors (ONLY FOR SIZE 2 DEVICES) external versions

## External braking resistors SK BRE4

External braking resistors (IP67) are intended for applications in which longer (lifting equipment), frequent (cyclic operation) or intensive (highly dynamic positioning applications) braking is to be expected. They are mounted directly on the frequency inverter. Typically, they can develop high surface temperatures (>70 °C), which exclude their use in an explosive atmosphere.

## Note

The brake resistors listed here are designed for typical applications with occasional braking. In case of doubt or for applications with higher braking power (lifting equipment), we recommend targeted planning of the necessary brake resistor. Please contact the NORD DRIVESYSTEMS Group directly.

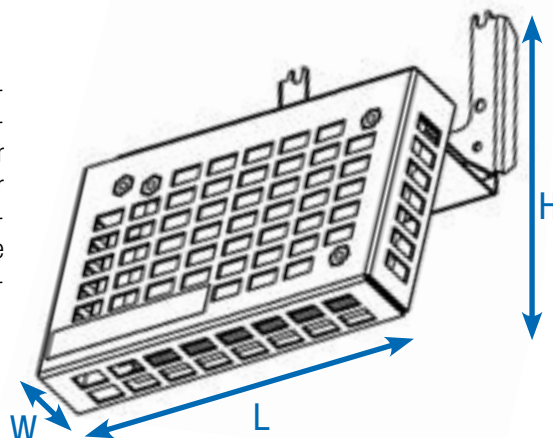

Frequency inverters SK 180E / SK190E	Resistor type Material No.	Resistance [Ω]	Continuous output [W]	Power consumption <sup>1</sup> [kW]	(Overall) dimensions L x W x H [mm]
1/3~ 230V  0.75 ... 1.5 kW	SK BRE4-1-100-100 275 273 005	100	100	2.2	150 x 61 x 178
	Alternatively: SK BRE4-2-100-200 275 273 105	100	200	4.4	255 x 61 x 178
3~ 400V  1.5 ... 2.2 kW	SK BRE4-1-200-100 275 273 008	200	100	2.2	150 x 61 x 178
	Alternatively: SK BRE4-2-200-200 275 273 108	200	200	4.4	255 x 61 x 178

<sup>1</sup> Permissible max. once within 120 s

# Accessories

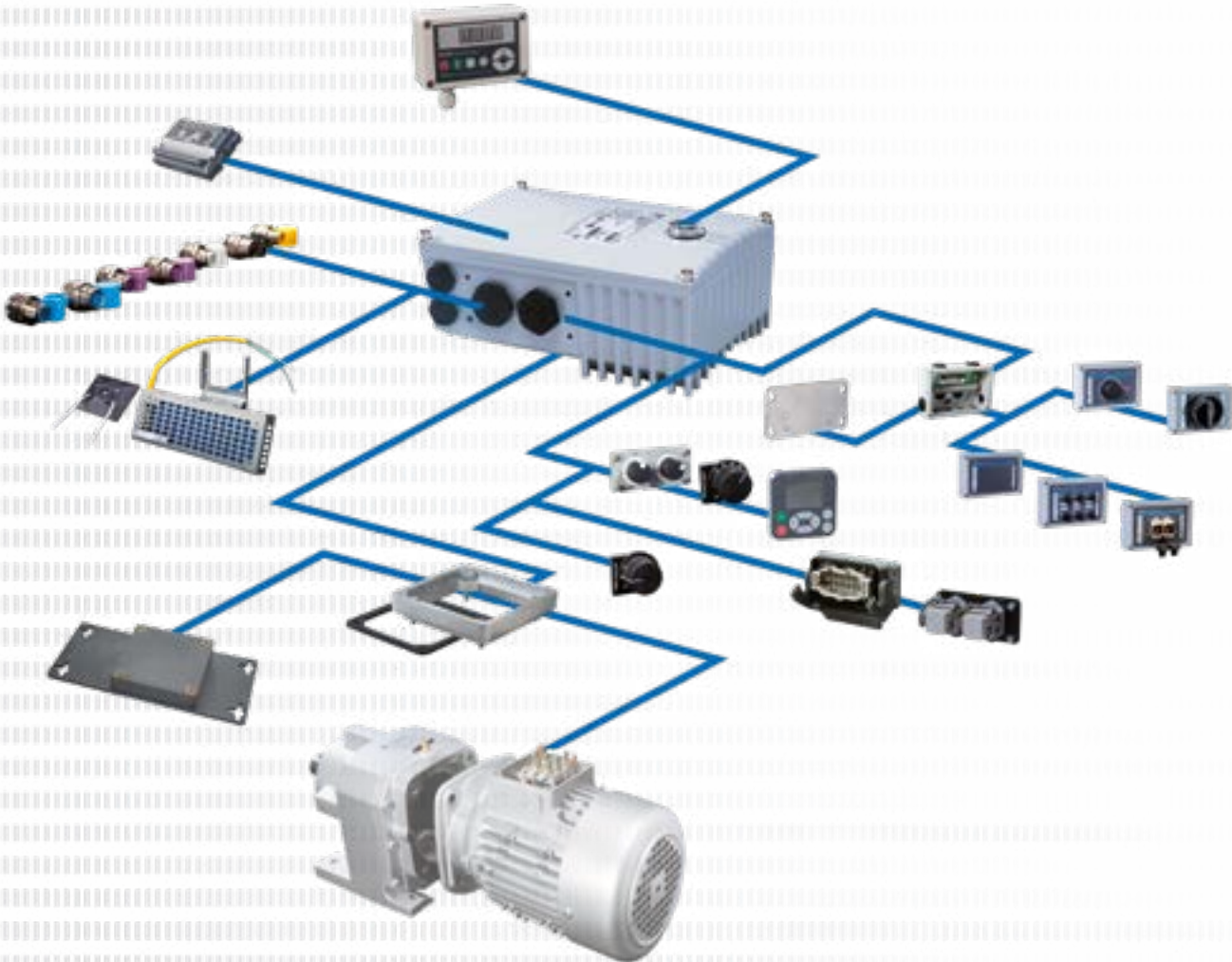



Please find a full range of accessories below that can be equally used for different series. This primarily applies to our decentralised devices of the NORDAC *LINK*, NORDAC *ON*, NORDAC *FLEX*, NORDAC *BASE* and NORDAC *START* series.

---

Operation  
and parameterisation

Seite 18



---

Interfaces  
for communication

Page 21



---

24 V power supply units,  
potentiometers, switches, signal converters  
and more

Page 26



---

System connectors  
for power and control connections

Page 30



---

Connection technology  
Cables





Page 34



# Operation and parameterisation

## Control and parameterisation units /software

Designation Material No.	Description	Remarks
 ParameterBox SK PAR-5H 275281614	Control and parameterisation, LCD (illuminated), plain text display in 14 languages, direct control of up to five devices, memory for five device data sets, convenient control keypad, communication via RS485, including 1.5 m connection cable. Handheld, suitable for installation in a control cabinet door. IP54	Connection for data exchange with NORDCON STUDIO to a PC (USB 2.0), (standard "USB-C" connection cable required, e.g. material number: 275292100) Power supply, e.g. directly via frequency inverter or PC

Designation Material No.	Description	Remarks
 <p>NORDAC CONTROL I/O SK TIE5-CIO 278-910-150</p>	Suitable for testing analogue and digital I/Os. Handheld, IP20	
<p>Control box SK POT1-1 278-910-120</p> 	Potentiometer 0 ... 100% (0 ... 10 V), switch Left/AUS/Right, including 3 m connection cable. Handheld, wall mounting, IP66	
<p>Control box SK POT1-2 278-910-140</p> 	Suitable for control, potentiometer 0 ... 100 % (0 ... 10 V), switch Left/AUS/Right, including 20 m connection cable. Handheld, wall mounting, IP66	
<p>SimpleSetpointBox SK SSX-3A 275-281-513</p> 	Suitable for control and parameterisation, 4-digit, 7-segment display, direct control of a device, 3 operating modes, convenient control keypad. Handheld, wall mounting, IP54	Electrical data: 19.2 ... 28.8 V DC, 35 mA, supply e.g. directly via the frequency inverter, communication via RS-485 or IO link

Designation  
Material No.

Description

Remarks

Adapter cable  
RJ12-SUB-D9  
278.910.240



To connect the frequency inverter to the serial interface of a PC via SUB-D9

Length: approx. 3 m

Connection set  
SK TIE4-RS232-USB  
275.274.604



To connect the frequency inverter to the serial interface of a PC via USB 2.0

Consisting of adapter cable RJ12-SUB-D9 and RS-232 to USB inverter  
Length: approx. 3 m + 0.5 m

Control and  
parameterisation  
software NORDCON



Software for control and parameterisation as well as commissioning assistance and fault analysis of NORD electronic drive technology. Parameter names in 14 languages

Free download:  
[www.nord.com](http://www.nord.com)

NORDAC  
ACCESS BT  
Bluetooth-Stick  
SK TIE5-BT-STICK  
275.900.120















Interface for wireless connection to a mobile terminal device (e.g. tablet or smartphone) via Bluetooth. With the aid of the NORDCON APP, the NORDCON software for mobile terminal devices, enables smart operation and parameterisation as well as commissioning assistance and fault analysis of NORD electronic drive technology.

NORDCON APP available free of charge for Android and iOS



# Communication interfaces

## Field bus extensions







Variant	Designation Material No.	Installation Attached / separate	Protection class	Number of inputs / outputs	Description	Remarks
PROFIBUS DP®	 SK CU4-PBR 275 271 000	● ○	IP20	2 digital inputs	Interface as gateway for direct connection of up to four devices to a PROFIBUS DP® field bus. Digital signals can alternatively be connected via the front M12 round plug connector (only M12 modules)	Baud rate: maximum 12 MBd  Protocol: DPV 0 and DPV 1  SK TU4 modules plus matching SK TI4-TU-BUS / SK TI4-TU-BUS-C connection unit
	 SK CU4-PBR-C' 275 271 500	● ○	IP20	2 digital inputs		
	 SK TU4-PBR 275 281 100	○ ●	IP55	4 digital inputs		
	 SK TU4-PBR-C 275 281 150	○ ●	IP66	2 digital outputs		
	 SK TU4-PBR-M12 275 281 200	○ ●	IP55			
	 SK TU4-PBR-M12-C 275 281 250	○ ●	IP66			
CANopen®	 SK CU4-CAO 275 271 001	● ○	IP20	2 digital inputs	Interface as gateway for direct connection of up to four devices to a CANopen® field bus. Digital signals can alternatively be connected via the front M12 round plug connector (only M12 modules)	Baud rate: maximum 1 MBaud  Protocol: DS 301 and DS 402  SK TU4 modules plus matching SK TI4-TU-BUS / SK TI4-TU-BUS-C connection unit
	 SK CU4-CAO-C' 275 271 501	● ○	IP20	4 digital inputs		
	 SK TU4-CAO 275 281 101	○ ●	IP55	2 digital outputs		
	 SK TU4-CAO-C 275 281 151	○ ●	IP66			
	 SK TU4-CAO-M12 275 281 201	○ ●	IP55			
	 SK TU4-CAO-M12-C 275 281 251	○ ●	IP66			

- Available as standard
- Not available

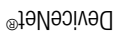
<sup>1</sup> Version with varnished circuit boards for applications in IP6X devices

# Communication interfaces











## Field bus extensions

Variant	Designation Material No.	Installation	Attached / separate Protection class	Number of inputs / outputs	Description	Remarks
	 SK CU4-DEV 275 271 002	●	○ IP20			
	 SK CU4-DEV-C <sup>1</sup> 275 271 502	●	○ IP20	2 digital inputs		
	 SK TU4-DEV 275 281 102	○	● IP55		Interface as gateway for direct connection of up to four devices to a DeviceNet <sup>®</sup> field bus.	Baud rate: maximum 500 kBaud
	 SK TU4-DEV-C 275 281 152	○	● IP66	4 digital inputs	Digital signals can alternatively be connected via the front M12 round plug connector (only M12 modules)	Profile: AC-Drive and NORD-AC
	 SK TU4-DEV-M12 275 281 202	○	● IP55	2 digital outputs		SK TU4 modules plus matching SK T14-TU-BUS / SK T14-TU-BUS-C connection unit
	 SK TU4-DEV-M12-C 275 281 252	○	● IP66			

<sup>1</sup> Version with varnished circuit boards for applications in IP6X devices

- Available as standard
- Not available



# Communication interfaces Industrial Ethernet extensions

Variant	Designation Material No.	Installation	Attached / separate	Protection class	Number of inputs / out- puts	Description	Remarks
Industrial Ethernet	 SK CU4-ETH 275271027	●	○	IP20	2 digital inputs	Interface as gateway for direct connection of up to four devices to the Industrial Ethernet. Parameterisation may be used with a choice between the following dialects: EtherCAT, EtherNet/IP, PROFINET IO	Baud rate: max. 100 Mbaud, EtherCAT: CoE, PROFINET IO: Conformance class B and C
	 SK CU4-ETH-C 275271527	●	○	IP20	2 digital inputs		
	 SK TU4-ETH 275281132	○	●	IP55	8 digital inputs	Connection of the bus cable via the front RJ45 or M12 circular connectors (only TU4 modules).	
	 SK TU4-ETH-C 275281182	○	●	IP66	2 digital outputs		
	 SK TU4-ETH-M12 275281233	○	●	IP55	2 digital outputs		
	 SK TU4-ETH-M12-C 275281283	○	●	IP66			
POWERLINK	 SK CU4-POL 275271018	●	○	IP20	2 digital inputs	Interface as gateway for direct connection of up to four devices to a POWERLINK field bus. Connection of the bus cable via the front M12 round plug connector (only TU4 modules)	Baud rate: maximum 100 Mbaud, SK CU4 module: Derating (see data sheet)
	 SK CU4-POL-C' 275271518	●	○	IP20	2 digital inputs		
	 SK TU4-POL 275281118	○	●	IP55	8 digital inputs	SK TU4 modules plus matching SK T14-TU-BUS / SK T14-TU-BUS-C connection unit	
	 SK TU4-POL-C 275281168	○	●	IP66	2 digital outputs		

<sup>1</sup> Version with varnished circuit boards for applications in IP6X devices

- Available as standard
- Not available

# Communication interfaces and connection units

Variant	Designation Material No.	Installation Attached / separate	Protection Class	Number of inputs / outputs	Description	Remarks
	SK CU4-IOE2 275 271 007	● ○	IP20	2 <sup>2</sup> digital and 2 <sup>3</sup> analogue inputs,		Analogue signals: IN / OUT: 0(2) ... +10 V or 0(4) ... 20 mA
	SK CU4-IOE2-C <sup>1</sup> 275 271 507	● ○	IP20	2 analogue outputs		
 IO extensions	SK CU4-IOE 275 271 006	● ○	IP20	2 digital and 2 <sup>3</sup> analogue inputs,		Analogue signals: IN: -10 V ... +10 V or 0(4) ... 20 mA  OUT: 0(2) ... +10 V or 0(4) ... 20 mA  SK TU4 modules plus matching SK T14-TU-BUS / SK T14-TU-BUS-C connection unit
	SK CU4-IOE-C <sup>1</sup> 275 271 506	● ○	IP20	1 analogue output	Sensor and actuator signal processing, connection via terminal bar Alternative connection of digital signals via front M12 round plug connector (only M12 modules)	
	SK TU4-IOE 275 281 106	○ ●	IP55	4 digital and 2 analogue inputs,		
	SK TU4-IOE-C 275 281 156	○ ●	IP66	2 digital and 1 analogue output		
	SK TU4-IOE-M12 275 281 206	○ ●	IP55			
	SK TU4-IOE-M12-C 275 281 256	○ ●	IP66			

<sup>1</sup> Version with varnished circuit boards for applications in IP6X devices

<sup>2</sup> Digital inputs can optionally be used as digital inputs or outputs

<sup>3</sup> Analogue inputs can optionally be used as analogue or digital inputs

- Available as standard
- Not available



Variant	Designation Material No.	Installation / separate Protection class	Description
	SK T14-TU-BUS 275 280 000	<input type="radio"/> IP55	Connection unit for SK TU4-.... bus interfaces or IO - extensions (IP55), including RS-232 diagnostic interface (RJ12 port)
	SK T14-TU-BUS-C 275 280 500	<input type="radio"/> IP66	Connection unit for SK TU4-.... bus interfaces or IO - extensions (IP66), including RS-232 diagnostic interface (RJ12 port)
	SK T14-WMK-TU 275 274 002	<input type="radio"/> IP66	For separate mounting of SK TU4... modules with SK T14-TU-...

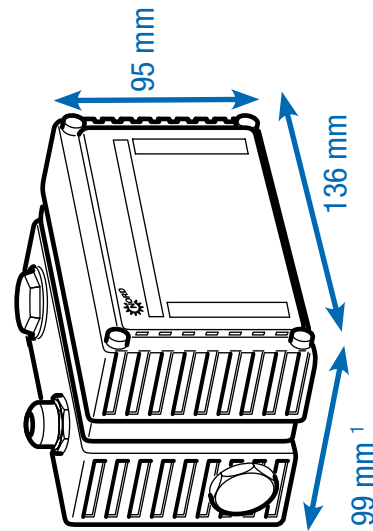

- Available as standard
- Not available



<sup>1</sup> Depth varies for versions with connections on the front side.



# Supply and control

## 24 V power supply units, potentiometer and switches

Variant	Designation Material No.	Installation / separate Protection class	Description	Remarks
	SK CU4-24V-123-B 275 271 108	● ○ IP20	Output: 24 V DC, 420 mA	For connection to 115 V/230 V devices, including AD converter for evaluation of a 10 kΩ - potentiometer
	SK CU4-24V-123-B-C <sup>1</sup> 275 271 608	● ○ IP20	Output: 24 V DC, 420 mA	
	SK CU4-24V-140-B 275 271 109	● ○ IP20	Output: 24 V DC, 420 mA	For connection to 400 V/500 V devices, including AD converter for evaluation of a 10 kΩ - potentiometer
	SK CU4-24V-140-B-C <sup>1</sup> 275 271 609	● ○ IP20	Output: 24 V DC, 420 mA	
	SK TU4-24V-123-B 275 281 108	○ ● IP55	Output: 24 V DC, 420 mA	For connection to 115 V/230 V devices, including AD converter for evaluation of a 10 kΩ - potentiometer
	SK TU4-24V-123-B-C 275 281 158	○ ● IP66	Output: 24 V DC, 420 mA	plus suitable connection unit SK TI4-TU-NET/SK TI4-TU-NET-C
	SK TU4-24V-140-B 275 281 109	○ ● IP55	Output: 24 V DC, 420 mA	For connection to 400 V/500 V devices, including AD converter for evaluation of a 10 kΩ potentiometer
	SK TU4-24V-140-B- 275 281 159	○ ● IP66	Output: 24 V DC, 420 mA	plus suitable connection unit SK TI4-TU-NET/SK TI4-TU-NET-C

<sup>1</sup> Version with varnished circuit boards for applications in IP6X devices













- Available as standard
- Not available

Variant	Designation Material No.	Installation	Attached / separate Protection Class	Description	Remarks
Power supplies with control unit	 SK TU4-POT-123-B 275 281 110	<input type="radio"/>	<input checked="" type="radio"/> IP55	Output: 24 V DC, 420 mA	For connection to 115 V / 230 V devices, including setpoint adjuster 0% ... 100% and keys "ON R" - "OFF" - "ON L" plus suitable SK T14-TU-NET/SK T14-TU-NET-C connection unit
		<input type="radio"/>	<input checked="" type="radio"/> IP66	Output: 24 V DC, 420 mA	
	SK TU4-POT-140-B 275 281 111	<input type="radio"/>	<input checked="" type="radio"/> IP55	Output: 24 V DC, 420 mA	For connection to 400 V / 500 V devices, including setpoint adjuster 0% ... 100% and keys "ON R" - "OFF" - "ON L" plus suitable SK T14-TU-NET/SK T14-TU-NET-C connection unit
		<input type="radio"/>	<input checked="" type="radio"/> IP66	Output: 24 V DC, 420 mA	
Connection units	 SK T14-TU-NET 275 280 100	<input type="radio"/>	<input checked="" type="radio"/> IP55		SK TU4-... connection unit for power supply units (IP55)
	SK T14-TU-NET-C 275 280 600	<input type="radio"/>	<input checked="" type="radio"/> IP66		SK TU4-... connection unit for power supply units (IP66)
	 SK TIE4-WMK-TU 275 274 002	<input type="radio"/>	<input type="radio"/> IP66		For separate mounting of SK TU4... modules with SK T14-TU-...

- Available as standard
- Not available

# Supply and control

## Signal converters and more

Variant	Designation Material No.	Installation Attached / separate Protection Class	Description	Remarks
Control elements	 SK CU4-POT 275 271 207	○ ● IP66	Switches and potentiometers	Switches: "ON R" - "OFF" - "ON L", 10 - kΩ potentiometer
	 SK TIE4-SWT 275 274 701	○ ● IP66	Switch	"ON R" - "OFF" - "ON L"
	 SK TIE4-POT 275 274 700	○ ● IP66	Potentiometer	10 kΩ potentiometer
	 SK ATX-POT 275 142 000	○ ● IP66	Potentiometer	10 kΩ - potentiometer, approved for use in ATEX Zone 22 3D
	 SK CU4-REL 275 271 011	● ○ IP20	2x AIN / AOUT, 2 DIN / relay	Converter for analogue signals -10 ... +10 V to 0 ... 10 V, 2 x changeover relay outputs 1 A (≤ 30 V), controlled via a digital input
	 SK CU4-REL-C' 275 271 511	● ○ IP20		
	 SK CU4-REL-POW 275 271 012	● ○ IP20	2x AIN / AOUT, 2 DIN / relay	Converter for analogue signals -10 ... +10 V to 0 ... 10 V, 2 x changeover relay outputs 8 A (≤ 30 V), controlled via a digital input
	 SK CU4-MBR 275 271 010	● ○ IP20	230 V / 400 V, max. 0.5 A	For direct control and supply of an electromagnetic holding brake
	 SK CU4-MBR-C' 275 271 510	● ○ IP20		
	 SK CU4-SSR 275 271 124	● ○ IP20	2x DIN / relay	Relay outputs (NO), suitable for AC / DC (max. 277 V AC, 850 mA / 24 V DC +/- 25%, 850 mA), control either synchronously via a digital input or individually via one digital input each
 SK CU4-SSR-C' 275 271 624	● ○ IP20			
Signal converter and relay	 SK CU4-SSR-400 275 271 128	● ○ IP20	2x DIN / relay	Relay outputs (NO), suitable for AC (480 V AC +10%, max. 300 mA), control either synchronously via a digital input or individually via one digital input each
	 SK CU4-SSR-400-C' 275 271 628	● ○ IP20		

<sup>1</sup> Version with varnished circuit boards for applications in IP6X devices

- Available as standard
- Not available

Variant	Designation Material No.	Installation Attached / separate Protection class	Description	Remarks
	SK CU4-PD2 275 271 026	● ○ IP20	Module for residual voltage dissipation	Load resistance 3 x 160 kOhm, ≤ 550 V AC/DC, ≤ 20 A
	SK CU4-PD2-C <sup>1</sup> 275 271 526	● ○ IP20		
Switch	SK TU4-MSW 275 281 123	○ ● IP55	1 ~ 100 - 240 V / 3 ~ 200 - 500 V, 16 A	Switch to disconnect the device from the power supply, black twist grip plus suitable SK T14-TU-MSW/SK T14-TU-MSW-C connection unit
	SK TU4-MSW-C 275 281 173	○ ● IP66	1 ~ 100 - 240 V / 3 ~ 200 - 500 V, 16 A	
Connection units	SK T14-TU-MSW 275 280 200	○ ● IP55		SK TU4-... connection unit for maintenance switches (IP55)
	SK T14-TU-MSW-C 275 280 700	○ ● IP66		SK TU4-... connection unit for maintenance switches (IP66)
	SK TIE4-WMK-TU 275 274 002	○ ○ IP66		For separate mounting of SK TU4... modules with SK T14-TU-...

<sup>1</sup> Version with varnished circuit boards for applications in IP6X devices

- Available as standard
- Not available

# Perfect connections with system plug connectors

The use of optionally available plug connectors for power and control connections not only makes it possible to replace the drive unit with almost no loss of time in case of servicing, but also minimises the danger of installation errors when connecting the device. This enables the perfect construction of an energy or communication bus. Typical plug connector versions are summarised below.



## Plug connectors for power connections

Plug connectors from various manufacturers are available for the motor or mains connection for rated currents of up to 20A.

Type	Data	Designation	Material No.
Input (power and control voltage)	400 V, 16 A + 24 V, 4 A	SK TIE4-HANQ4-M-LE-MX	275 274 113
Input (power and control voltage)	400 V, 16 A + 24 V, 10 A	SK TIE4-NQ16-K-LE	275 274 133
Input and output (power and control voltage)	400 V, 32 A + 24 V, 4 A	SK TIE4-2HANQ4-M-LE-LA	275 274 112
Input and output (power and control voltage)	400 V, 40 A + 24 V, 6 A	SK TIE4-2HANQ4-M-LE-LA-6mm	275 274 119
Power input	500 V, 16 A	SK TIE4-HAN10E-M1B-LE	275 135 070
Power input	500 V, 16 A	SK TIE4-HAN10E-M2B-LE	275 135 000
Power input	500 V, 16 A	SK TIE4-HANQ8-M-LE-MX	275 135 030
Power input	690 V, 20 A	SK TIE4-QPD4SPM	275 274 185
Power output	500 V, 16 A	SK TIE4-HAN10E-M2B-LA	275 135 010
Power output	500 V, 16 A	SK TIE4-HANQ8-M-LA-MX	275 135 040
Motor output	500 V, 16 A	SK TIE4-HAN10E-M2B-MA	275 135 020
Motor output	500 V, 16 A	SK TIE4-HANQ8-M-MA-MX	275 135 050
Power input + motor or power output	400 V, 16 A	SK TIE4-2HANQ5-K-LE-LA	275 274 110



## Plug connectors for control connections

Various M12 round plug connectors are available as flanged plugs or flanged sockets. The plug connectors are intended for installation in an M16 screw fitting on the device and can be oriented in any direction. The protection class (IP67) of the plug connector only applies in the screwed state. The cover caps correspond to the colour version as does the plastic body of the plug connector. Expansion and reducer adapters are available for installation in an M12 or M20 screw fitting.



Type	Version	Designation	Material No.
System bus IN	Plug connectors	SK TIE4-M12-SYSS	275 274 506
System bus OUT	Bushing	SK TIE4-M12-SYSM	275 274 505
Power supply	Plug connectors	SK TIE4-M12-POW	275 274 507
Sensors/actuators	Bushing	SK TIE4-M12-INI	275 274 503
Sensors/actuators	Plug connectors	SK TIE4-M12-INP	275 274 516
Analogue signal	Bushing	SK TIE4-M12-ANA	275 274 508
AS-Interface	Plug connectors	SK TIE4-M12-ASI	275 274 502
AS-Interface – Aux	Plug connectors	SK TIE4-M12-ASI-AUX	275 274 513
CANopen® / DeviceNet® IN	Plug connectors	SK TIE4-M12-CAO	275 274 501
CANopen® / DeviceNet® OUT	Bushing	SK TIE4-M12-CAO-OUT	275 274 515
Ethernet	Bushing	SK TIE4-M12-ETH	275 274 514
PROFIBUS® (IN + OUT)	Connector + socket	SK TIE4-M12-PBR	275 274 500
Connection extension	M12 - M16	SK TIE4-M12-M16	275 274 510
Connection reduction	M20 – M16	SK TIE4-M20-M16	275 274 511



# Installation locations for system connectors

## System connectors

The devices provide various screw fittings which can be used for the installation of cable glands or system connectors. Screw-in reduction or expansion adapters enable the connection of additional cable cross sections as required.

### NORDAC BASE

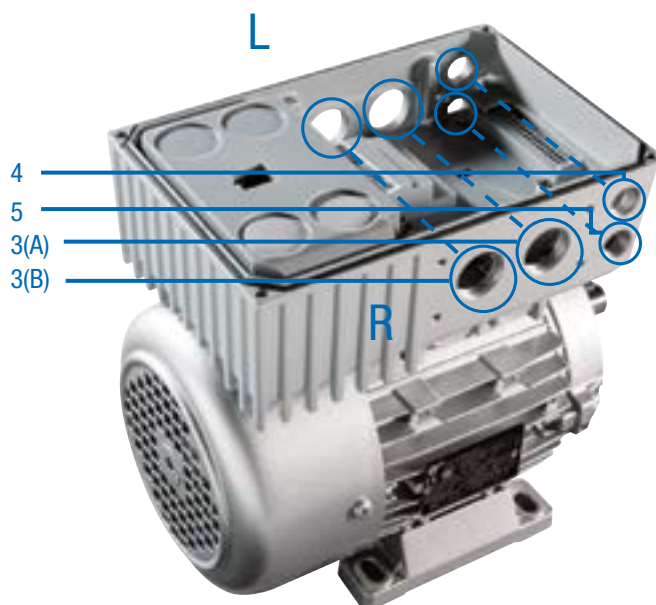

### Option locations (R or L assignment, view towards the motor fan)

- 3 L/R 2 x M25 screw fitting (A/B)
- 4 L/R M16 screw fitting
- 5 L/R M16 screw fitting

The plug connectors for the power connection are installed at position 3 (R or L).



## Connection unit - Technology Unit

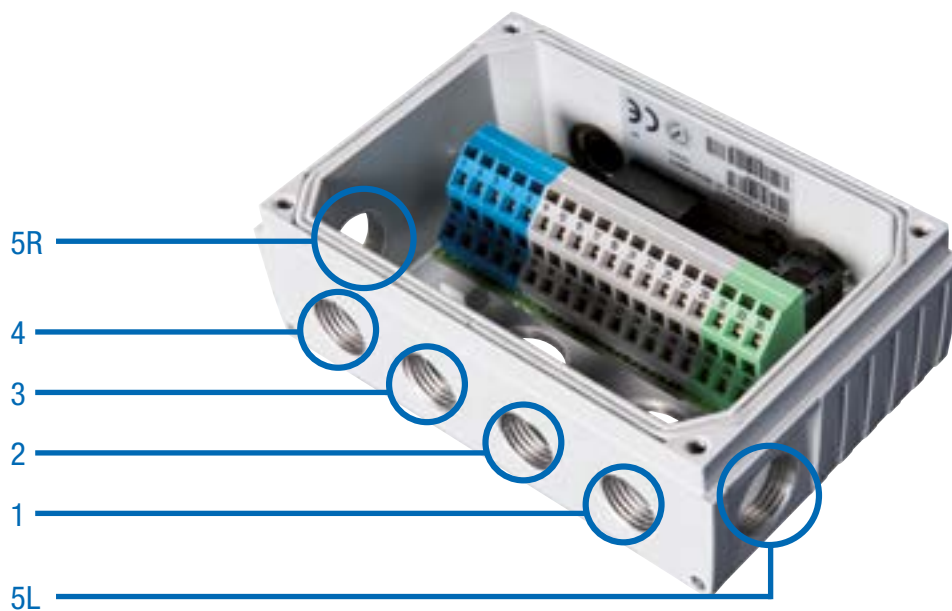

### Optionsplätze der SK TI4-TU-...

- 1 M16 screw fitting
- 2 M16 screw fitting
- 3 M16 screw fitting
- 4 M16 screw fitting
- 5 L/R M20 screw fitting



# Not to be underestimated – the correct connection method

With the NORDAC *LINK*, *FLEX*, *BASE* and *START* frequency inverters and motor starters, the NORD DRIVESYSTEMS Group provides the right product for motor control for all decentralised drive technology applications. The advantages, such as short motor cables, improved EMC and installation without control cabinets are obvious.

Connection of the decentralised components (motor and electronics) is made either with a permanent connection with cable glands<sup>1</sup> or can be in the form of plug connectors. However, the full advantages of decentralised drive technology are only achieved with the selection of plug-in connectors.

- ▶ Quick and simple electrical connection
- ▶ Minimisation of connection errors
- ▶ Minimum installation effort for installation, maintenance and servicing
- ▶ Reduced downtime in case of replacement

NORD supplies an extensive range of connection and control cables.

- ▶ Depending on the version, connecting cables include power connection cables (mains and motor) and if necessary cables for thermistors as well as 24 V DC control voltage.
- ▶ Control cables are exclusively used for transmitting control signals (encoder, bus, IO signals).

Connection and control cables are supplied pre-assembled. They are available in various lengths and can optionally be provided with open ends or plug connectors. Typically, all cables<sup>2</sup> are shielded.

<sup>1</sup> Not for NORDAC *LINK*, NORDAC *ON*

<sup>2</sup> Except for mains connection/daisy chain cables



# Designation of pre-assembled cables

## Pre-assembled cables

- ▶ Cables for motor and frequency inverter connection
- ▶ Mains connection and signal cables
- ▶ Customised plug connectors and cable lengths

## SC H4G2.5 HQ8SMM H10E1SMF 1.5 UL

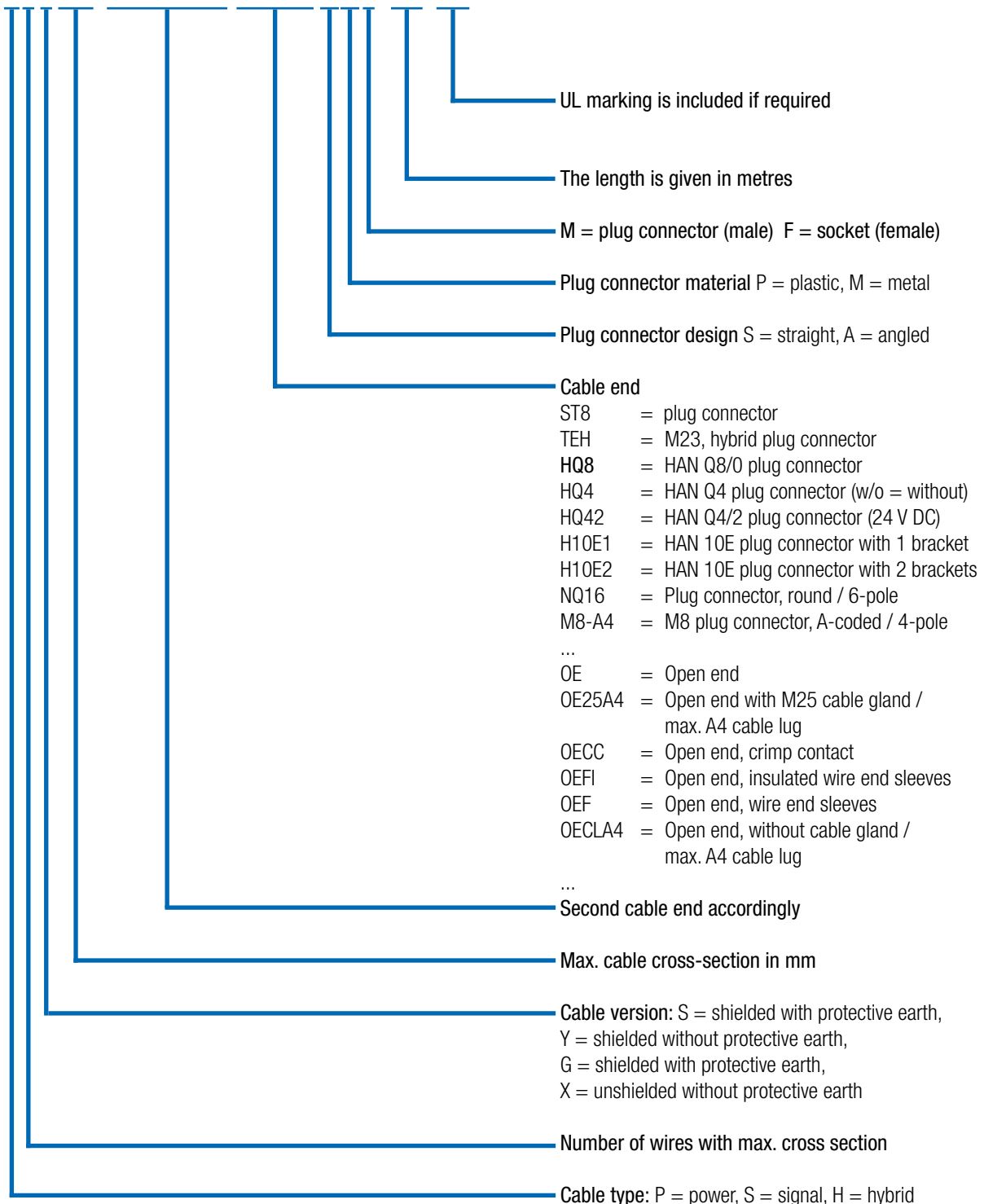

# Technical data cables

The design depends on the ambient conditions and the type of installation and must be decided by the customer. All options can be requested from NORD according to the specific project.

Feature	Standard	Options
Conductor material	Copper	-
Installation type	Permanent installation	-
Cable insulation	Polyvinyl chloride (PVC)	Polyurethane (PUR)
Protective sleeve	No	On request
Cable length	Motor cables: 1.5 m – 3.0 m – 5.0 m Mains cables: 1.5 m – 3.0 m – 5.0 m Daisy chain cables: 1.5 m – 3.0 m – 5.0 m Encoder cables: 1.5 m – 3.0 m – 5.0 m Brake resistor cables: 2.0 m – 3.0 m	On request

# Motor cables

## Product overview – Motor cables

Depending on the motor, the following shielded motor connection cables are available.

### NORDAC LINK, FLEX, BASE, START

Designation	Motor power [kW]	Certification	Part number for length [m]		
			1.5	3	5
SC H4S2.5 HQ8SPM OE20A4 UL	0,12 - 0,37	EU / UL	275 274 800	275 274 801	275 274 802
SC H4S2.5 HQ8SPM OE25A4 UL	0,55 - 1,5	EU / UL	275 274 805	275 274 806	275 274 807
SC H4S2.5 HQ8SPM OE32A4 UL	2,2 - 3,0	EU / UL	275 274 825	275 274 826	275 274 827
SC H4S2.5 HQ8SPM OE32A5 UL	4,0	EU / UL	275 274 830	275 274 831	275 274 832
SC H4S4 HQ8SPM OE32A6 UL	5,5 - 9,2	EU / UL	275 274 835	275 274 836	275 274 837
SC H4S2.5 HQ8SPM H10E1SMF	0,12 - 4,0	EU	275 274 810	275 274 811	275 274 812

### NORDAC ON

Designation	Motor power [kW]	Certification	Part number for length [m]		
			1.5	3	5
SC H4S1 ST8SMM OE20A4 UL	63 – 71 IE1 - IE3	EU / UL	275 274 690	275 274 691	275 274 692
SC H4S1 ST8SMM OE20A4 UL WOB <sup>1</sup>	63 – 71 IE1 - IE3	EU / UL	275 274 617	275 274 618	275 274 619
SC H4S1 ST8SMM OE25A4 UL	80 – 90 IE1 - IE3 71 IE5+	EU / UL	275 274 695	275 274 696	275 274 697
SC H4S1 ST8SMM OE25A4 UL WOB <sup>1</sup>	80 – 90 IE1 - IE3 71 IE5+	EU / UL	275 274 621	275 274 622	275 274 623
SC H4S1 ST8SMM HQ8SMF UL	NORD Motorstecker „MS21“	EU / UL	275 274 685	275 274 686	275 274 687
SC H4S1.5 TEH51SVM TEH51SVF MBE <sup>2</sup>		EU / UL	in preparation	in preparation	in preparation

### Frequency inverter/Motor starter connection

### Motor connection

### Required motor option<sup>1</sup>



Open ends

ZKK



MS31 or MS31E

<sup>1</sup>For further information about motor options please refer to motor catalogue M7000

# Mains cables / Daisy chain cables

## Product overview – Mains cable

The following unshielded mains cables are available. A simple plug-in connection for frequency inverters can be achieved with the HQ4 variant. With a further variant (HQ42) a 24 V DC supply can also be implemented.

Designation	24 V DC supply	Certification	Part number for length [m]		
			1.5	3	5
SC P4G2.5 HQ4SPF OE	no	EU	275 274 840	275 274 841	275 274 842
SC P4GA14 HQ4SPF OE UL	no	UL		275 274 241	275 274 242
SC H4G4 HQ42SPF OE	yes	EU	275 274 845	275 274 846	275 274 847
SC H4GA12 HQ42SPF OE UL	yes	UL		275 274 246	275 274 247
SC H6G2.5 NQ16SPF OE UL <sup>1</sup>	yes	UL	275 274 218	275 274 219	275 274 220

<sup>1</sup> only NORDAC *ON*



A daisy chain cable is designed for looping the mains connection (plug connections on both sides) from one frequency inverter to the next. The variants as for mains cables are available. These cables are also unshielded.

Designation	24 V DC supply	Certification	Part number for length [m]		
			1.5	3	5
SC P4G4 HQ4SPM HQ4SPF	no	EU	275 274 850	275 274 851	275 274 852
SC P4GA12 HQ4SPM HQ4SPF UL	no	UL		275 274 251	275 274 252
SC H4G4 HQ42SPM HQ42SPF	yes	EU	275 274 855	275 274 856	275 274 857
SC H4GA12 HQ42SPM HQ42SPF UL	yes	UL		275 274 256	275 274 257
SC H6G2.5 NQ16SPM NQ16SPF UL <sup>1</sup>	yes	UL	275 274 288	275 274 289	275 274 290

<sup>1</sup> only NORDAC *ON*



# Brake resistor cable / Control cables

## Product overview – Braking resistor cables

The following shielded cables are available for connecting an external brake resistor

Designation	Certification	Part number for length [m]	
		2	3
SC P3S2.5 HQ2SPM OE	EU	275 274 881	275 274 899
SC P3SA14 HQ2SPM OE UL	UL	275 274 280	275 274 281



## Product overview – Control cables

Control cables for connection to an encoder are typically connected with so-called "M12 plug connectors". The following system solutions are available for encoder connection.

Designation	Motors			Encoders <sup>1</sup>	Cable type	Control cable Length - Part No.
	IE1-3	IE4	IE5+			
SC S4Y0.25 M12-B4MM M12-A8SMF	●	○	○	IG12P - 19 651 501	HTL without zero track	1.5 m - 275 274 675
				IG22P - 19 651 511		3.0 m - 275 274 676
				IG42P - 19 651 521		5.0 m - 275 274 677
SC S5S0.25 M12-A5SPM M12-A5SPF	○	●	○	IG22P5 - 19 651 910	HTL with zero track	1.5 m - 275 274 874
	○	○	●	IG62P5 - 19 605 002		3.0 m - 275 274 876
						5.0 m - 275 274 877
SC S5Y0.25 M12-A5SMM M12-A8SMF	○	●	○	IG22P8 - 19 651 911	HTL with zero track	1.5 m - 275 274 645
						3.0 m - 275 274 646
						5.0 m - 275 274 647

- Available as standard
- Not available

<sup>1</sup> Further information about encoders can be obtained from motor catalogue M7000.

**Headquarters:**

Getriebebau NORD GmbH & Co. KG

Getriebebau-Nord-Str. 1

22941 Bargteheide, Deutschland

T: +49 (0) 45 32 / 289 - 0

F: +49 (0) 45 32 / 289 - 22 53

[info@nord.com](mailto:info@nord.com)