

**Drive solutions for
the bulk goods industry**
Complete drive systems from a single source

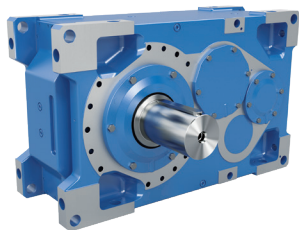

NORD DRIVESYSTEMS Group



Industrial Gear Units

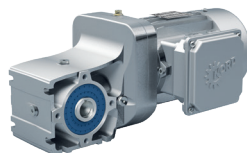

Geared Motors



Frequency Inverters and Motor Starters

- ▶ Headquarters and technology centre in Bargteheide near Hamburg.
- ▶ Innovative drive solutions for more than 100 branches of industry.
- ▶ 7 production locations with cutting edge technology produce gear units, motors, VFDs, and more to provide complete drive systems from a single source.
- ▶ NORD has 48 subsidiaries in 36 countries and further sales partners in more than 50 countries, provide local inventory, assembly, technical support, and industry-leading customer service.
- ▶ More than 4,100 employees throughout the world create customized solutions.



Headquarters in Bargteheide



Gear unit production



Inverter production



Motor production



Production and assembly



Motor assembly



Integrated solutions for the special requirements of the bulk goods industry

- ▶ Simple commissioning
- ▶ Easy maintenance and safe, reliable operation
- ▶ Lower total cost of ownership
- ▶ Modular design
- ▶ Energy savings
- ▶ Project and product support
- ▶ Global network

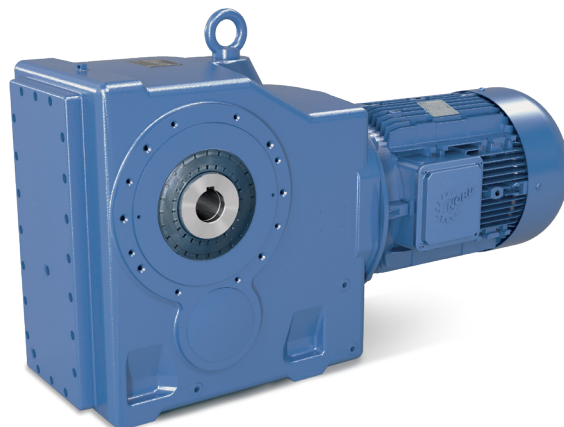

Drive solutions for the bulk goods industry

1 Storage

Bulk goods are intermediately stored (and homogenized) in storage compound systems (longitudinal or rotary blending beds) or silos/bunkers before they are conveyed to the next process.

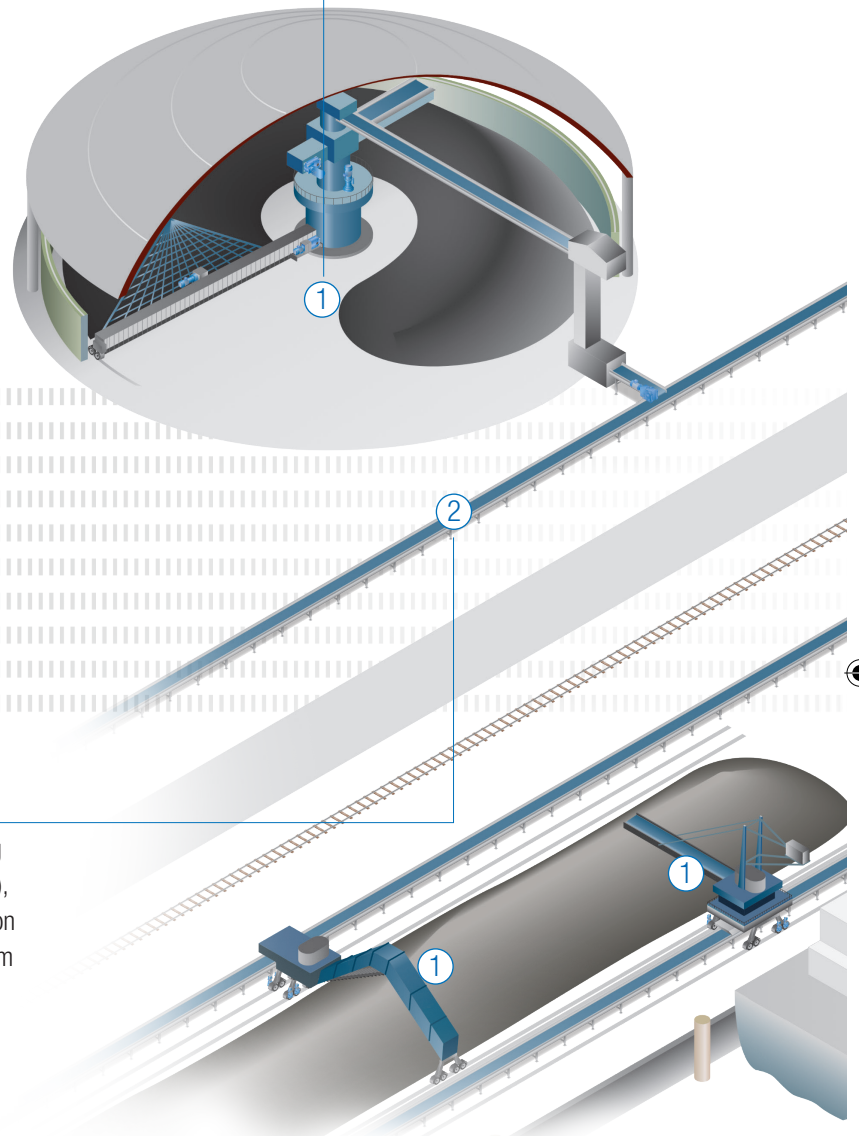

2 Conveying

Conveyors differing with regard to the conveying direction (horizontal, vertical, inclining, declining), mass flow rate, conveyor length, and construction design are needed to convey the bulk goods from process step to process step.

NORD DRIVESYSTEMS is one of the world's leading drive technology companies. Our solutions are used throughout the world for a wide variety of applications in many industry sectors.

NORD DRIVESYSTEMS provides:

- ▶ Extensive knowledge of applications and technical support
- ▶ Complete drive solutions from a single source
- ▶ Strong global presence and service
- ▶ Thousands of installed drives in the bulk goods industry
- ▶ Wide range of products with high quality standards
- ▶ Great reliability, economy and service life
- ▶ Recognized product quality compliant with international standards



3 Weighing and metering

Before reaching the next process step, the bulk goods are usually metered (and weighed) to ensure the correct amount is added to the process.

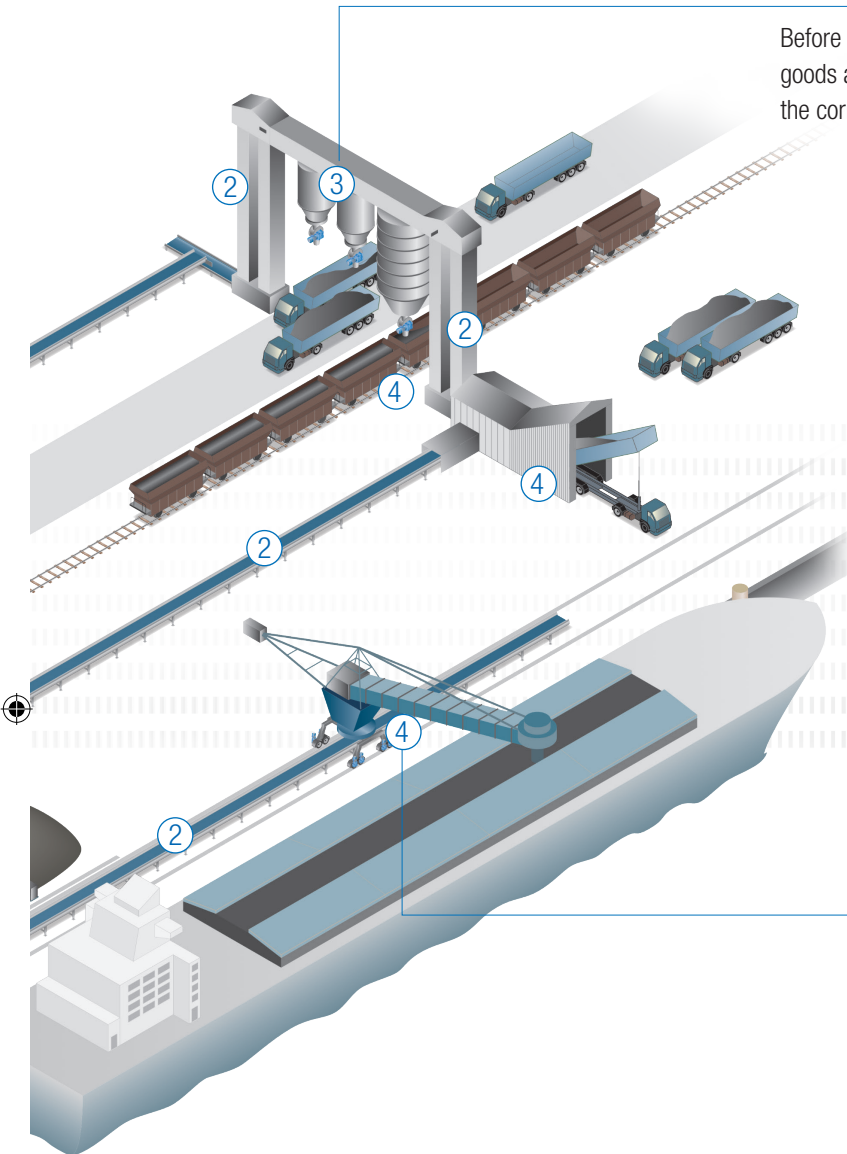

4 Loading and unloading

Ships, trains and lorries must be loaded and unloaded for global bulk goods transport.

We support you with:

Design

- ▶ myNORD
- ▶ Reduced number of variants
- ▶ Project design/optimization
- ▶ Drive system design
- ▶ Application solutions
- ▶ Green solutions
- ▶ CAD drawings

Commissioning

- ▶ Plug-and-Play
- ▶ Support
- ▶ Training
- ▶ Documentation
- ▶ Smart commissioning

Service

- ▶ Predictive maintenance (PLC function)
- ▶ Spare parts, express shipping
- ▶ Global presence
- ▶ 24/7 support



Drive solutions for the bulk goods industry

NORD DRIVESYSTEMS develops and manufactures scalable drive solutions for all areas of the bulk goods industry.

NORD DRIVESYSTEMS developed as early as 1981 the revolutionary block housing construction. From a single piece a closed gearbox housing is manufactured which combines all transmission elements.

- ▶ One housing block in which all bearings are integrated
- ▶ Complete machining in one clamping
- ▶ High output torques
- ▶ High axial and radial load capacity
- ▶ Highest operational reliability
- ▶ Long service life
- ▶ Low-noise operation



Storage

Bulk goods are intermediately stored (and homogenised) in storage compound systems (longitudinal or rotary blending beds) or silos / bunkers before they are conveyed to the next process step. Different bulk goods require different plant arrangements that need customized drives.

- ▶ All drives from a single source (geared motors, industrial gear units, planetary gear units)
- ▶ Optimally matched components (gear unit, motor, frequency inverter, couplings, brakes)
- ▶ Flexible implementation of customer-specific design specifications (e.g. drive pinions, motor swing bases)



Conveying

Conveyors differing with regard to the conveying direction (horizontal, vertical, inclining, declining), mass flow, conveyor length, and construction are needed to convey the bulk goods from process step to process step. Reliable and robust drives made by NORD DRIVESYSTEMS ensure an uninterrupted material flow.

- ▶ Reliable
- ▶ Easy to service and maintain
- ▶ Optimally matched components (gear unit, motor, frequency inverter, couplings, brakes)
- ▶ Customer-specific engineering

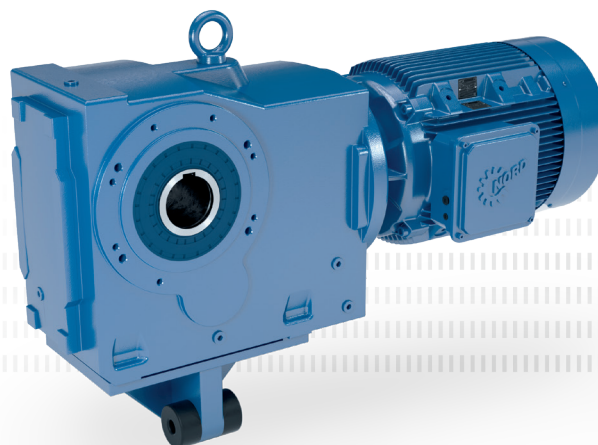

Weighing and metering

Before reaching the next process step, the bulk goods are usually metered (and weighed) to ensure the correct amount is added to the process. NORD drives can be controlled individually to intelligently adjust the mass flow – for precise, dynamic bulk goods infeed control.

- ▶ Dynamic
- ▶ With integrated PLC function
- ▶ Optimally matched components (gear unit, motor, frequency inverter, couplings, brakes)
- ▶ Flexible implementation of customer-specific process requirements (e.g. automatic blockage detection and elimination, automatic mass flow regulation)

Loading and unloading

Ships, trains and lorries must be loaded and unloaded for global bulk goods transport. Reliable NORD drives make sure this is done quickly and safely.

- ▶ All drives from a single source (geared motors, industrial gear units, planetary gear units)
- ▶ High system availability
- ▶ Optimally matched components (gear unit, motor, frequency inverter, couplings, brakes)
- ▶ Customer-specific engineering



Drive solutions for the bulk goods industry

Energy efficient, safe and proven drive solutions from a single source



Energy efficient

Drive solutions by NORD DRIVESYSTEMS are environmentally friendly and help reduce operating costs and minimize CO₂ emissions.

- ▶ High efficiency helical and bevel gear units achieve optimum power transmission performance.
- ▶ NORD motors comply with international energy efficiency classes up to IE4.
- ▶ NORD frequency inverters have energy saving functions to effectively reduce energy consumption.
- ▶ NORD components are optimally matched to obtain ultimate efficiency.

Safe

Reliability is our main focus when developing our drive solutions. All of our system components are precisely matched to each other and ensure smooth operation.

- ▶ UNICASE™ gear units ensure precise positioning of bearings and shafts.
- ▶ Highly precise gearing ensures minimum wear and a long service life.
- ▶ Efficient protection of drive system and plant by implementing couplings matched to the process and the gear unit (e.g. hydraulic couplings).
- ▶ The gear units are extraordinarily robust, run very quietly and have a particularly long service life.
- ▶ NORD frequency inverters are equipped with safety functions to protect the drive system electronically.

Tried-and-tested

Demanding ambient conditions are common in the bulk goods industry. This includes large temperature fluctuations, abrasive environments, and rough operating conditions. The reliability and cost-effectiveness of NORD solutions for these challenges have proven themselves in the bulk goods industry throughout the world.

- ▶ Full featured NORD drive solutions based on a modular system, consisting of frequency inverter, motor, gear unit, couplings, and brakes are selected as the basis.
- ▶ They are combined with solutions individually developed and designed according to customer requirements.



Innovative drive solutions for demanding ambient conditions

The extensive product portfolio of NORD DRIVESYSTEMS is constantly being further developed. Through continuous investment in the latest development, manufacturing and automation technology, we are always in a position to offer our customers optimal drive systems for the specific requirements of their respective industry.



Drive solutions for the bulk goods industry

MAXXDRIVE® Industrial Gear Units (Catalogue G1050)

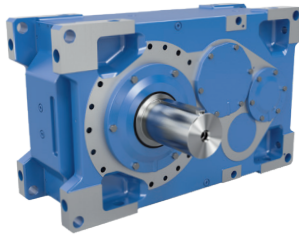

- ✓ Parallel axis and right-angled gear units
- ✓ High axial load capacity
- ✓ Long life, low-maintenance
- ✓ UNICASE™ housing
- ✓ Hollow or solid shaft
- ✓ Foot motor (IEC B3)
- ✓ Hydraulic clutch
- ✓ Backstop
- ✓ Brake
- ✓ All components can be mounted on a motor swing arm or a steel frame.
- ✓ High Efficiency IE3 motor
- ✓ ATEX motors for applications in explosive environments

Sizes: 11
 Performance: 2.5 – 8,075 HP
 Torque range: 132,800 – 2,495,900 lb-in
 Ratio: 5.54 – 30,000:1

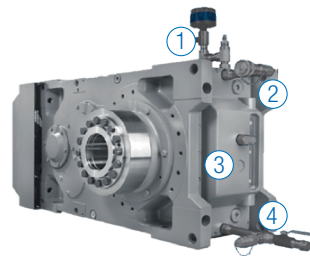

The maintenance package from NORD DRIVESYSTEMS is a combination of several protective measures that ensures your investment will have a long operating life.

- 1 Drying agent filter
- 2 Quick fit filter trolley connection
- 3 Oil inspection glass
- 4 Quick fit filter trolley connection and oil drain cock

UNICASE™ CLINCHER™ Parallel Shaft Gear Units (Catalogue G1000)



- ✓ Foot, flange or face mounted
- ✓ Hollow or solid shaft
- ✓ Compact design
- ✓ UNICASE™ housing

Sizes: 15
 Performance: 0.16 – 268 HP
 Torque range: 974 – 885,075 lb-in
 Ratio: 4.03 – 15,685.03:1

UNICASE™ Helical Bevel Gear Units (Catalogue G1000)

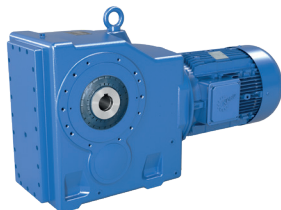

- ✓ Foot, flange or face mounted
- ✓ Hollow or solid shaft
- ✓ UNICASE™ housing

Sizes: 11
 Performance: 0.16 – 268 HP
 Torque range: 1,593 – 442,537 lb-in
 Ratio: 8.04 – 13,432.68:1



NORDAC FLEX SK 200E Frequency Drives (Catalogue E3000)

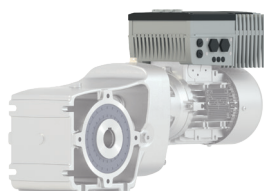

- ✓ Energy-saving function
- ✓ Integrated POSICON positioning control
- ✓ Integrated PLC

Sizes: 4

Voltage: 1 ~ 110 – 120 V, 1 ~ 200 – 240 V, 3 ~ 200 – 240 V, 3 ~ 380 – 500 V

Power range: 0.33 – 30 HP

NORDAC PRO SK 500E Frequency Drives (Catalogue E3000)



- ✓ Stand-alone operation
- ✓ 4 parameter sets
- ✓ Sensorless current vector control (ISD control)
- ✓ Integrated PLC

Sizes: 11

Voltage: 1 ~ 110 – 120 V, 1 ~ 200 – 240 V, 3 ~ 200 – 240 V, 3 ~ 380 – 480 V

Power range: 0.33 – 200 HP

Motors (Catalogue M7000)

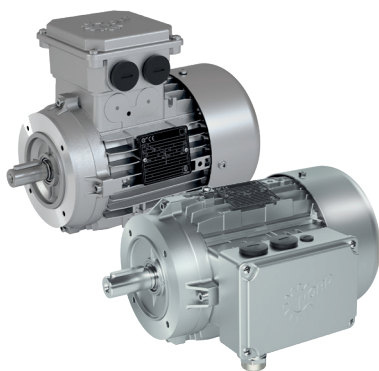

- ✓ IE3 motors from 0.16 HP (Size 63)
- ✓ IE4 synchronous and asynchronous motors



Explosion-protected drive solutions

NORD DRIVESYSTEMS supplies customized explosion-protected motors and geared motors.

- ▶ Versions and equipment according to individual requirements
- ▶ Configuration processes validated according to ISO 9001
- ▶ Safe, SAP-supported modular system

Dust explosion-protected motors

- ▶ According to category 2D or 3D
- ▶ For zone 21 or 22
- ▶ According to EN 60079-31
- ▶ Ignition protection type Ex t (protected by housing)

Dust explosion-protected gear units

- ▶ According to category 2D or 3D
- ▶ For zone 21 or 22
- ▶ According to EN 13463
- ▶ Ignition protection type c (design safety)





US

Headquarters
NORD Gear Corporation
800 NORD Drive
Wauwaukee, WI 53597
T: 888 314 6673
info.us@nord.com

CA

NORD Gear Limited
41 West Drive
Brampton, ON L6T4A1
T: 800 668 4378
info.ca@nord.com

MX

NORD DRIVE SYSTEMS SA DE CV
Av. Industria Textil B.6
Parque Industrial PYME, Huimilpan
QRO - Mexico 76950
T: 52 442 688 7110
info.mx@nord.com

© 2020 NORD Gear Corporation.
All rights reserved. UNICASE is a trademark
of NORD DRIVESYSTEMS and MAXXDRIVE is
a registered trademark of NORD Gear Corporation.

